

# CUBE2-HC90

Project Name:	
Type:	



### APPLICATION

The CUBE2-HC90 creates a design statement for contemporary and traditional architectural interiors. The angular luminaires are decorative and suitable for a multiple of applications like offices, retails, museums and galleries as well as high ceiling application such as lobbies.

### FEATURE:

- Housing is formed by cold-rolled steel with a highly reflective die-formed white painted steel reflector.
- The snap-in acrylic lens has a matte finish and a diffuser (.125" thick) which is removable for lamp replacement.
- 90 degree and 135 degree luminaires are available.

### MOUNTING:

- Pendant, surface, wall mount, recessed (drywall and T-bar) mount available.
- Mounting restrictions apply on some of the recessed housings, please refer to the ordering chart or dimension page to find availability.

### LED:

- High quality array LEDs.
- LM80
- Color Temperature: 3000/3500/4000/5000 (K)
- Color Rendering Index: > 80 (optional > 90).
- Nominal Lamp Life: 100,000 hours.
- Reported L70 hours: +60,000 (55°C).

### ELECTRICAL:

- High power factor electronic driver, operate from a 120 ~ 277 Vac input range, 50 / 60 Hz.
- Features included over voltage protection, surge, short circuit protection and over load protection.
- Power Factor: typical > 0.95, THD <20, meets Class1 or Class 2 circuit.
- 0-10V dimmable driver as standard.
- 0-10VDC dimming 1%~100%.
- Operating temperature: -4°F (-20°C) ~ 122°F (50°C).

### <ELCU-200>

- Guarantees emergency lighting remains ON or is turned on when power to the control device is lost.
- Interfaces with fire alarm panel or security system.
- "Watchdog" feature allows emergency loads to be controlled in tandem with normal power loads.
- UL listed for use in emergency circuits.

### FINISH:

- Standard powder-coat textured white painted finish on exposed trim, consult factory for custom colors.
- Comes with snap-in acrylic lens as standard.

### LISTING:

- UL / CUL listed.
- Listed to UL 1598 and UL 8750.
- UL listed for dry & damp location.
- Assembled in USA (optional).
- BAA compliant (optional).
- 5 years limited warranty.
- 7 or 10 years limited warranty. (optional) <sup>5</sup>
- Bluetooth Mesh System available, please contact factory for more information.

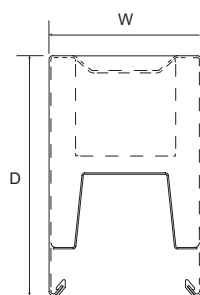

Width: 2.5 (64)  
Depth: 4 (101)

All dimensions are in inches (millimeters).

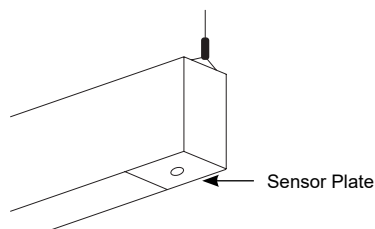

Lutron Vive Integral fixture control installation



EasySense fixture-mount installation

# CUBE2-HC90

## CONFIGURATIONS

Series	Size	Model #	AC Input	Fixture Lumen Output (4000K)		Lumen Efficiency (4000K)	
CUBE2-HC90	11	D18L	9.9W	1280.46 lm (100% Down)	1280.46 lm	129.34 lm/W	
		D27L	14.85W	1641.66 lm (100% Down)	1641.66 lm	110.55 lm/W	
		D36L	19.8W	2122.36 lm (100% Down)	2122.36 lm	107.19 lm/W	
		D48L	26.4W	2811.6 lm (100% Down)	2811.6 lm	106.5 lm/W	
		D54L	29.7W	3146.41 lm (100% Down)	3146.41 lm	105.94 lm/W	
		18L/18L	19.8W	1179.37 lm (57.6% Down) / 868.15 lm (42.4% Up)	2047.52 lm	103.41 lm/W	
		27L/18L	24.75W	1651.86 lm (63% Down) / 970.15 lm (37% Up)	2622.01 lm	105.94 lm/W	
		27L/27L	29.7W	1769.05 lm (57.6% Down) / 1302.22 lm (42.4% Up)	3071.27 lm	103.41 lm/W	
		36L/18L	29.7W	2093.38 lm (65.5% Down) / 1102.63 lm (34.5% Up)	3196.01 lm	107.61 lm/W	
		48L/18L	36.3W	2383.15 lm (64.6% Down) / 1305.95 lm (35.4% Up)	3689.1 lm	101.63 lm/W	
		48L/27L	41.25W	2485.9 lm (59.3% Down) / 1706.3 lm (40.7% Up)	4192.2 lm	101.63 lm/W	
	54L/18L	39.6W	2937.92 lm (73% Down) / 1086.63 lm (27% Up)	4024.55 lm	101.63 lm/W		
	54L/27L	44.55W	3140 lm (65.5% Down) / 1654 lm (34.5% Up)	4794 lm	107.61 lm/W		
	12 & 21	18L	14.85W	1921.29 lm (100% Down)	1921.29 lm	129.38 lm/W	
		27L	22.27W	2461.50 lm (100% Down)	2461.50 lm	110.53 lm/W	
		36L	29.7W	3182.95 lm (100% Down)	3182.95 lm	107.17 lm/W	
		48L	39.6W	4217.4 lm (100% Down)	4217.4 lm	106.5 lm/W	
		54L	44.55W	4720.51 lm (100% Down)	4720.51 lm	105.96 lm/W	
		18L/18L	29.7W	1950.73 lm (57.6% Down) / 1435.96 lm (42.4% Up)	3386.69 lm	114.03 lm/W	
		27L/18L	37.12W	2477.46 lm (63% Down) / 1455.03 lm (37% Up)	3932.49 lm	105.94 lm/W	
		27L/27L	44.55W	2653.58 lm (57.6% Down) / 1953.32 lm (42.4% Up)	4606.91 lm	103.41 lm/W	
		36L/18L	44.55W	3140.08 lm (65.5% Down) / 1653.94 lm (34.5% Up)	4794.02 lm	107.61 lm/W	
		48L/18L	54.45W	3574.8 lm (64.6% Down) / 1958.95 lm (35.4% Up)	5533.75 lm	101.63 lm/W	
		48L/27L	61.8W	3724.45 lm (59.3% Down) / 2556.25 lm (40.7% Up)	6280.7 lm	101.63 lm/W	
	54L/18L	59.4W	4406 lm (73% Down) / 1629.63 lm (27% Up)	6035.63 lm	101.61 lm/W		
	54L/27L	66.82W	4709.77 lm (65.5% Down) / 2480.73 lm (34.5% Up)	7190.5 lm	107.61 lm/W		
	22	18L	19.8W	2562.12 lm (100% Down)	2562.12 lm	129.40 lm/W	
		27L	29.7W	3283.33 lm (100% Down)	3283.33 lm	110.55 lm/W	
		36L	39.6W	4244.72 lm (100% Down)	4244.72 lm	107.19 lm/W	
		48L	52.8W	5623.2 lm (100% Down)	5623.2 lm	106.5 lm/W	
		54L	59.4W	6294.02 lm (100% Down)	6294.02 lm	105.96 lm/W	
		18L/18L	39.6W	2358.73 lm (57.6% Down) / 1736.30 lm (42.4% Up)	4095.03 lm	103.41 lm/W	
		27L/18L	49.5W	3303.73 lm (63% Down) / 1940.30 lm (37% Up)	5244.03 lm	105.94 lm/W	
		27L/27L	59.4W	3538.10 lm (57.6% Down) / 2604.45 lm (42.4% Up)	6142.55 lm	103.41 lm/W	
		36L/18L	59.4W	3954.11 lm (65.5% Down) / 2082.71 lm (34.5% Up)	6036.82 lm	101.63 lm/W	
		48L/18L	72.6W	4766.3 lm (64.6% Down) / 2612 lm (35.4% Up)	7378.3 lm	101.63 lm/W	
		48L/27L	82.5W	4971.9 lm (59.3% Down) / 3412.5 lm (40.7% Up)	8384.4 lm	101.63 lm/W	
		54L/18L	79.2W	5875.83 lm (73% Down) / 2173.26 lm (27% Up)	8049.09 lm	101.63 lm/W	
		54L/27L	89.1W	6280.14 lm (65.5% Down) / 3307.86 lm (34.5% Up)	9588 lm	107.61 lm/W	
	CUBE2-HC135	22	18L	19.8W	2562.12 lm (100% Down)	2562.12 lm	129.40 lm/W
			27L	29.7W	3283.33 lm (100% Down)	3283.33 lm	110.55 lm/W
			36L	39.6W	4244.72 lm (100% Down)	4244.72 lm	107.19 lm/W
			48L	52.8W	5623.2 lm (100% Down)	5623.2 lm	106.5 lm/W
			54L	59.4W	6294.02 lm (100% Down)	6294.02 lm	105.96 lm/W
			18L/18L	39.6W	2358.73 lm (57.6% Down) / 1736.30 lm (42.4% Up)	4095.03 lm	103.41 lm/W
27L/18L			49.5W	3303.73 lm (63% Down) / 1940.30 lm (37% Up)	5244.03 lm	105.94 lm/W	
27L/27L			59.4W	3538.10 lm (57.6% Down) / 2604.45 lm (42.4% Up)	6142.55 lm	103.41 lm/W	
36L/18L			59.4W	3954.11 lm (65.5% Down) / 2082.71 lm (34.5% Up)	6036.82 lm	101.63 lm/W	
48L/18L			72.6W	4766.3 lm (64.6% Down) / 2612 lm (35.4% Up)	7378.3 lm	101.63 lm/W	
48L/27L			82.5W	4971.9 lm (59.3% Down) / 3412.5 lm (40.7% Up)	8384.4 lm	101.63 lm/W	
54L/18L			79.2W	5875.83 lm (73% Down) / 2173.26 lm (27% Up)	8049.09 lm	101.63 lm/W	
54L/27L			89.1W	6280.14 lm (65.5% Down) / 3307.86 lm (34.5% Up)	9588 lm	107.61 lm/W	

CCT	Multiplier		
	3000K	3500K	5000K
Down only	0.9642	0.9822	1.0357
Up&Down	0.971	0.9856	1.029

## OUTPUT CURRENT

		Bi-Level		Tri-Level (Default)	
SW1	SW2	Config Range	Default	Config Range	Default
Close	Open	10% - 70%	40%	10% - 70%	30%
Open	Close	10% - 70%	40%	10% - 70%	70%
Close	Close	100%	100%	100%	100%
Open	Open	0%	0%	0%	0%

## WEIGHT

Item	lbs	kg
CUBE2-HC90	15.19	6.89
CUBE2-HC90-FT	17.37	7.88

# CUBE2-HC90

ORDERING INFORMATION

EXAMPLE: CUBE2-HC90-12-D27L-30K-UNV-X1-AC48

MODEL	SHAPE		SIZE		LED Downlight (per/each section)		LED Uplight <sup>1</sup> (per/each section)		Uplight DISTRIBUTION		COLOR TEMP.	
CUBE2	HC90	90 Degree	11	1' x 1'	D18L	18W LED	/U18L	18W LED	(Blank) UN15 UN30 UM UASY UBAT UPC	No optic Uplight Narrow 15° Uplight Narrow 30° Uplight Medium 60° Uplight Asymmetric 20° 24 Uplight Batwing 120° Non-optic clear cover	(Blank)	Leave blank if you wish to have different CCT for up and down, and fill out next section.
			12	1' x 2'	D27L	27W LED	/U27L	27W LED				
			21	2' x 1'	D36L	36W LED						
			22	2' x 2'	D54L	54W LED						
	HC135	135 Degree	22	2' x 2'	*Maximum wattage per each section - pendant : 75W(up & down light) - recessed mount : 54W(down light) * Contact factory for custom wattage or lumen requirement.							
	CM	Custom pattern (must provide a sketch on the last page of this spec sheet)										

SEPARATE COLOR TEMP. <sup>1</sup>		CRI		MOUNTING		VOLTAGE	
(Blank)	Leave blank if you wish to have different CCT for up and down, and fill out next section	(Blank)	80+ CRI	(Blank)	Pendant	UNV	120-277V
DXXUY	Indicate 27,30,35,40 or 50 for XX and YY (D represents Downlight, U represents Uplight)	C9	90+ CRI <sup>9</sup>	FT	Standard 1/2" Flange (drywall) <sup>2</sup>	120	120V
				G1	9/16", 15/16", 1" T-bar Ceiling Grid <sup>15, 20</sup>	277	277V
				SF	Spackle Flange (Trimless) <sup>16, 17, 20</sup>	347	347V <sup>18</sup>
				S	Ceiling Surface		
				W	Wall		
					* Limited mounting option(s) depending on the shape & size. Please see dimensions page to find availability.		

EM SECTION		FIXTURE FINISH <sup>10</sup>		CORD FINISH (for pendant)		CANOPY FINISH (for pendant)		CEILING TYPE (for pendant)	
(Blank)	None EM	(Blank)	Matte White RAL #9003 (Std.)	(Blank)	White (Std.)	(Blank)	White (Std.)	X1	15/16" grid T-bar ceiling
1SE	1 Section	*BK	Black RAL #9011	*BKC	Black	*BC	Black Canopy	X2	Hard ceiling
		*SV	Silver (RAL #9022)			*SC	Silver Canopy	X3	Sloped Hard ceiling
		**CC	Custom Color <sup>8</sup>			**CSS	Custom Canopy Color (White is Std.)	X4	9/16" T-bar ceiling
		*AMB	Anti-Microbial Coating (Matte Skye White)						
			* Non-standard finish with extra charge. ** Additional charge & set up fee.						

SUSPENSION LENGTH (for pendant)		LED DRIVER	
AC48	Adjustable Aircraft Cable Canopy 48"L	(Blank)	0-10V dim to 1% (Std.) (dim both uplight and downlight simultaneously)
AC96	Adjustable Aircraft Cable Canopy 96"L	UDSD	Separate Dimming Control of Uplight and Downlight (0-10V dim to 1%) <sup>7, 14</sup>
ST24	Stem Canopy 24"L	SP	Separate Power Control for Uplight and Downlight
ST48	Stem Canopy 48"L	ES566	eldoLED SOLodrive Natural Dimming to dark, 0-10V, 100% ~ 0.1% dim
	* Contact factory for custom length.	SD40	40% / 100% Bi-Level Step dim
		SDXX	XX% / 100% Bi-Level Step dim (Specify XX : 10% ~ 70%)
		PHSR	Philips Xitanium Sensor-Ready, Dali 5%~100% dim.
		PHDL	Philips Xitanium DALI driver, Dim to 5%
		ED560	eldoLED LightShape DALI dim to dark, 0.1% ~ 100%
		TDM	Triac Dim. (120V only)
		TD30/70	30% / 70% / 100% Tri-Level Step dim
		TDXX/YY	XX% / YY% / 100% Tri-Level Step dim (Specify XX, YY : 10% ~ 70%)
		LDE1	Hi-lume 1% EcoSystem LED driver with Soft-on, Fade-to-Black dimming technology, 100% ~ 1% dim
		ELV	ELV compatible (reverse-phase or trailing-edge), (120V only)
		TRIO	Tridonic IoT ready, 1-100% dim via Smart Module Interface (SMI), automated dimming/lighting controls via Enlighted Sensor Interface
		DTO	0-10V DIM-TO-OFF
		DMX	DMX512 control system (Only available with RGB+W option)
		DLM	Wattstopper's DLM interface (Only available with RGB+W option)
		LTEA2W	Hi-lume 1% 2-wire LED driver (120V forward phase only)
		BLT	Bluetooth Mesh System (contact factory for more information)

OPTIONS		LIGHTING CONTROL SYSTEM	
<b>STB</b> Slip Through Bracket <sup>3</sup> <b>EM5MC</b> 810 LUMEN Emergency Ballast (32°F (0°C) ~ 131°F (55°C)) <b>EM7MC</b> 1134 LUMEN Emergency Ballast (32°F (0°C) ~ 122°F (50°C)) <b>EM10MC</b> 1620 LUMEN Emergency Ballast (32°F (0°C) ~ 131°F (55°C)) <b>EMG25</b> 4050 LUMEN EM Battery Backup (CEC Compliant EM) <sup>22, 23</sup> <b>EMC</b> CEC compliant EM <sup>4</sup> <b>GTD</b> Bodine Generator Transfer Device <b>GTD10DIM</b> Bodine Generator Transfer Device (0-10VDC Dimmer Override) <b>GLR</b> Fast Blow Fuse <sup>19</sup> <b>GMF</b> Slow Blow Fuse <sup>19</sup> <b>ARRA</b> Assembled in USA for Buy American Act <b>BAA</b> BAA(Buy American Act) and BABA(Build America Buy America) compliant <b>O7W</b> Optional 7 Years Limited Warranty <sup>5</sup> <b>O10W</b> Optional 10 Years Limited Warranty <sup>5</sup> <b>AMS</b> Bluetooth Mesh Wireless Sensor. Occupancy/Daylight/0-10V Dimming <b>DPMS</b> Daylight Dimming Photo Sensor (0-10 VDC Control), (LSR-301-S required if FD-301 is installed) <sup>21</sup> <b>SO</b> Dimming Wires connected to Sensor Only (available option on FS-205 non-Bluetooth AMS sensor only) <sup>6</sup> <b>LSR-301-S</b> Setup Remote Control for DPMS (Required for DPMS) <b>LSR-301-P</b> Occupant Remote Control for DPMS <b>COC</b> Separated EM feed for City of Chicago code compliance <sup>22</sup> <b>E1F</b> End feed on one end (Pre-drilled hole for 1/2" fitting) <b>E2F</b> End feed on both ends (Pre-drilled holes for 1/2" fitting)	<b>LUTRON VIVE</b>  <b>SNS200</b>  <b>RS-IR</b>  <b>SU-5E</b>  <b>RS-WS</b>  <b>IFS105SE</b> <b>PPA102S</b>	<u>&lt;Lutron Vive System Enabled&gt;</u>  <a href="#">Click Here!</a>  <u>&lt;EasySense&gt;</u> EasySense Fixture-mount occupancy sensing, daylight harvesting and task tuning in one device (Must be ordered with PHSR driver) <sup>11, 12</sup> IR dongle v2.0 for EasySense control <u>&lt;Enlighted&gt;</u> Enlighted IoT ready 0-10V Indoor Micro sensor with occupancy/vacancy detection, daylight harvesting, thermal sensing, task tuning, and room and zone control, Bluetooth enabled (Must be ordered with TRIOT) <sup>13</sup> Enlighted Room controller providing basic control functions of a standard wall switch with preset dimming capability  <u>&lt;Bluetooth&gt;</u> Bluetooth Mesh Wireless Sensor. Occupancy/Daylight/0-10V Dimming Bluetooth Powerpack (Consult factory for installation location)	

**NOTES:**

- Pendant only.
- Requires # STB as standard.
- Standard with "FT" mounting.
- Check with factory for more details.
- This limited warranty covers electrical parts only and does not apply to labor, equipment lease, or defect from improper installation or operation.
- Dimming wires provided and connected to sensor only, not for dimmer switch. (available with AMS and DPMS option)
- For separate dimming control, please be advised it may not be available when EM battery backup is added due to limited space. Please contact us for more information.
- Refer to color charts (RAL and/or Cardinal) in the separate attachment.
- Lumen per watt is around 15% less than standard CRI (80+).
- Cord is available in white or black. (Black is not available for the EM option)
- See NFC and IR manual in the separate attachment. If your phone is not compatible, please order "RS-IR" and follow the manual.
- Refer to Advanced Grouping Datasheet for its default setting and compatible wireless switches.
- "RS-WS" option can be added if wish to have a wall switch, please see Enlighted Room Controller in the separate attachment.
- Can have up to 2 power feeds depending on the configuration.
- Compatible with X1 ceiling type.
- Requires # STB as standard.
- Compatible with X2 ceiling type.
- 347V cannot work with Emergency Battery Backup.
- Must specify voltage, not available with 347V.
- Only available with HC90-22.
- Automatic on/off is not available. For automatic on/off, additional occupancy sensor is required or a manual on/off switch can be done.
- Contact factory for other emergency ballast options.
- For 3ft configuration, EM can only be remote mounted. Remote box is provided by others.
- Standard optic illuminates the wall. Optics can be field modified (reversed) to illuminate room.

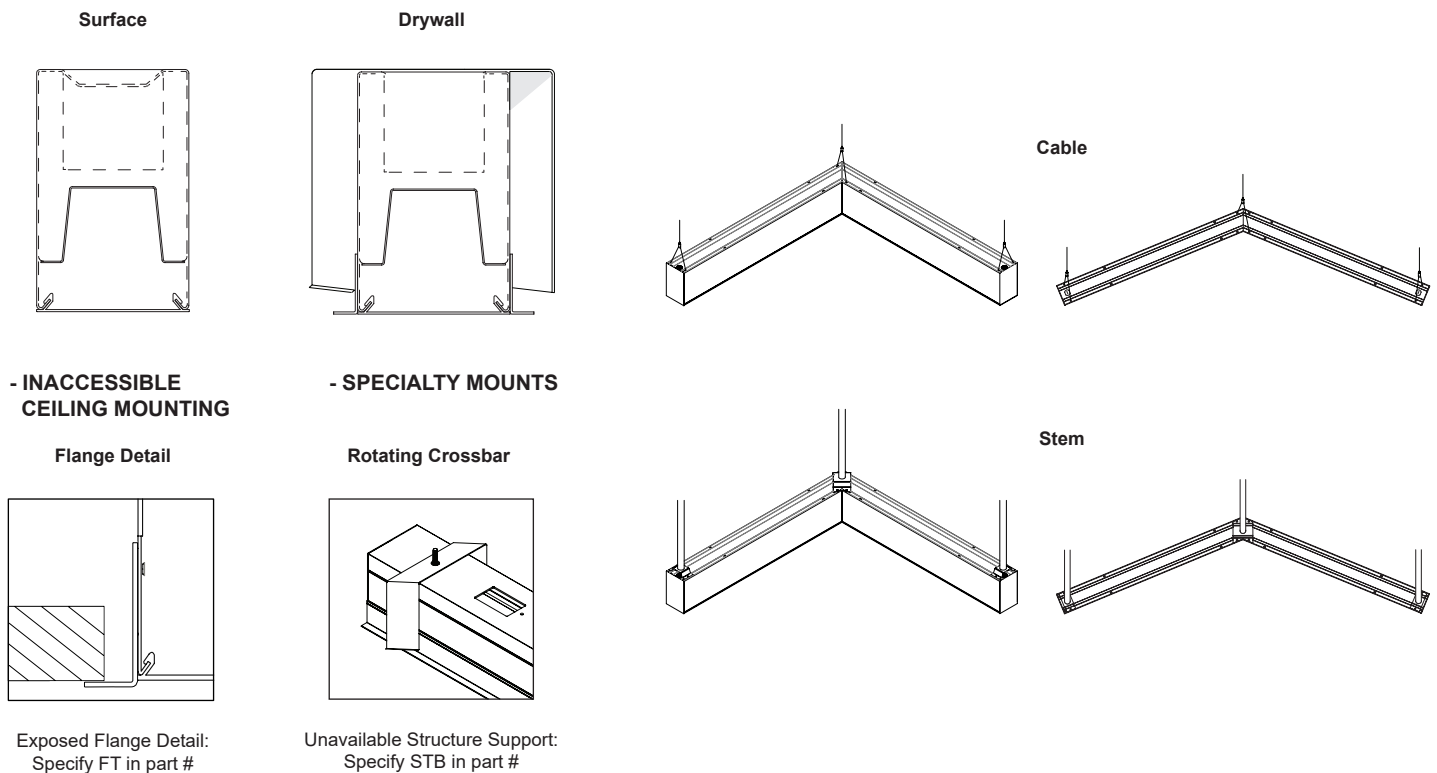

# CUBE2-HC90

## Pendant & Surface & Wall

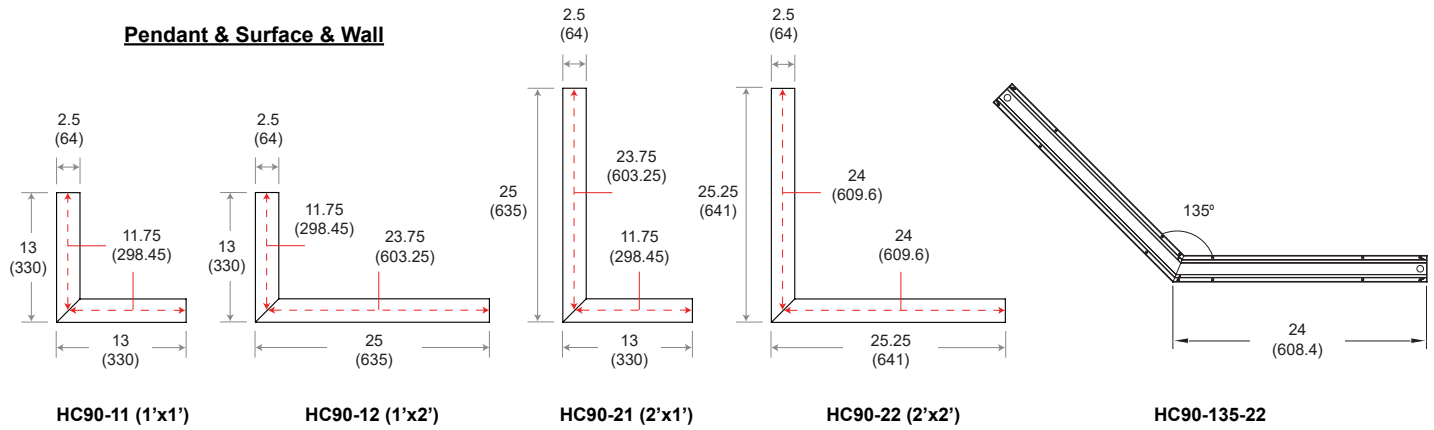

## Recessed

\* Measurements shown below are without flange.

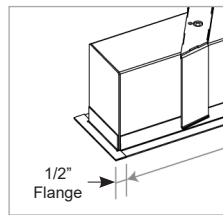
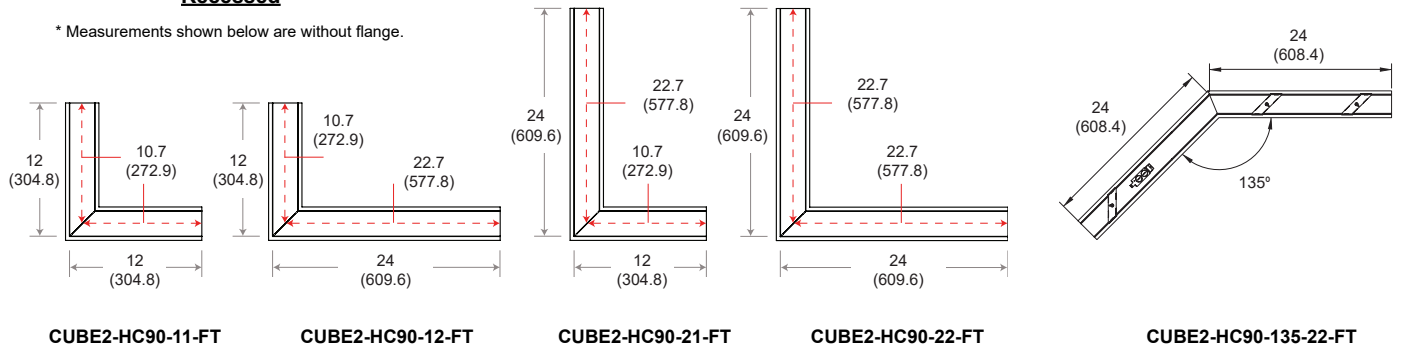

Flange is 0.078 (2) elevated.

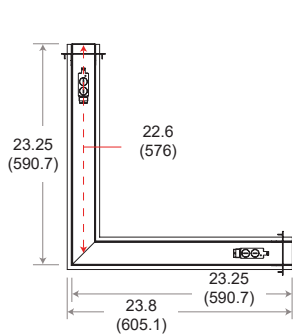
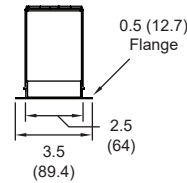

CUBE2-HC90-22-G1

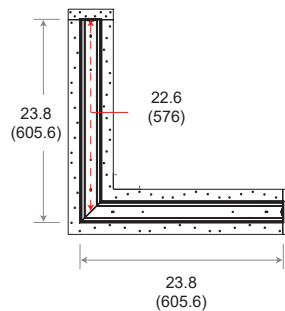
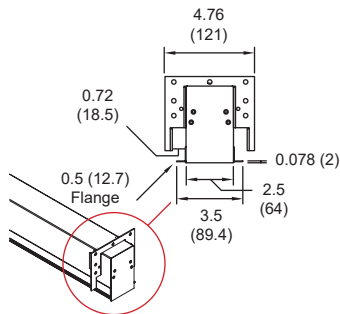

CUBE2-HC90-22-SF

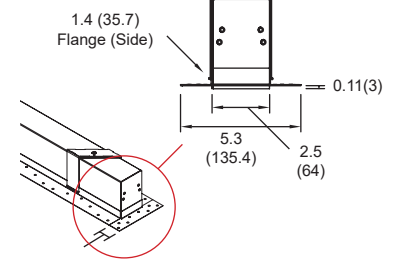

# CUBE2-HC90

COMPATIBLE DIMMER SWITCH (TABLE 1)

Model #	Brand	Compatible Dimmer Switch	
(Blank)	-	<Leviton>	IP710-LFZ
		<Lutron>	Nova: NFTV-dimmer plus PP-DV relay pack(s) Nova T: NTSTV-DV-dimmer Diva: DVTV-dimmer, DVSCTV-dimmer, plus PP-DV, relay pack(s), DVSTV-dimmer, DVSCSTV-dimmer GRAFIK Eye QS: QSGRJ-XP, plus GRX-TVI 0-10V interface GRAFIK Eye QS w/EcoSystem: QSGRJ-XE, QSGR-XE, plus GRX-TVI 0-10V interface PowPak: RMJ-5T
ES566	eldoLED SOLOdrive	<Busch-Jaeeger>	2112U-101
		<Jung>	240-10
		<Leviton>	IllumaTech - IP710-DLX
		<Lightoller Controls>	ZP600FAM120
		<Merten>	5729
		<Pass & Seymour>	CD4FB-W
		<Wattstopper>	DCLV1
		<Sensor Switch>	nIO EZ
		<Synergy>	ISD BC
		<ABB>	SD/S 2.16.1
		<Lutron>	Nova T: NTFTV Diva - DVTV-xx, NFTV GRAFIK Eye: GRX-TVI w GRX3503 Energy Savr Node: QSN-4T16-S TVM2 Module
		<Crestron>	GLX-DIMFLV8, GLXP-DIMFLV8, GLPAC-DIMFLV4-*, GLPAC-DIMFLV8-*, GLPP-DIMFLVEX-PM, GLPP-1DIMFLV2EX-PM, GLPP-1DIMFLV3EX-PM, DIN-AO8, DIN-4DIMFLV4, CLS-EXP-DIMFLV, CLCI-1DIMFLV2EX
ED560	eldoLED DUALdrive	<Lunatone>	SS-LUNAT PS2 30mA SS-LUNAT Touch or BT SS-LUNAT Comm
LDE1	Lutron 5-Series EcoSystem	<Lutron>	PowPak Dimming Modules: RMJ-ECO32-DV-B, FCJ/FCJS-ECO <sup>1,2</sup> Energi Savr Node (120V only): QSN-1EC0-S, QSN-2ECO-S GRAFIK Eye QS/Homeworks QS control unit (120V only): QSGRJ- _E(wireless) QSGR- _E Quantum Hub (120V only): QP2- _2C/4C/6C/8C Homeworks QS/myRoom Plus power module (120V only): LQSE-2ECO-D
PHSR <sup>3</sup>	Philips Xitanium Sensor-Ready	<Illumra>	<u>Single Rocker Self-Powered Light Switch (on/off, dim-up/down)</u> Illumra# ZBT-S1AWH Digi-Key# 1082-1033-ND <u>Dual Rocker Self-Powered Light Switch (on/off, dim-up/down, scene1,2)</u> Illumra# ZBT-S2AWH Digi-Key# 1082-1034-ND
TDM	KEystone	<Lutron>	Diva DV-600P, SkyLark S-600P, Ariadni AY-600P, Ariadni TG-603P, Maestro MA-600 (Digital), Diva CFL/LED DVCL-153P, Satin Colors DVSC-600P-SW
		<Leviton>	6641, IllumaTech IPI06-1LX, ToggleTouch TGI06-1LW (Digital)
ELV	KEystone	<Lutron>	MAELV-600BL (Digital), DVELV-300P, SkyLark SELV-300P
DTO	Philips Xitanium Gen.2 Philips Xitanium Sensor-Ready	<Lutron>	Nova T: #NTSTV-DV <a href="http://www.lutron.com/TechnicalDocumentLibrary/NovaTB.pdf">http://www.lutron.com/TechnicalDocumentLibrary/NovaTB.pdf</a> See page13.
LTEA2W	Lutron Hi-lume 2-wire (120V forward voltage only)	<Lutron>	Visit <a href="http://www.lutron.com/TechnicalDocumentLibrary/369543_ENG.pdf">http://www.lutron.com/TechnicalDocumentLibrary/369543_ENG.pdf</a> for a list of compatible dimmer switches.

NOTES:

- All devices connected to one FCJ/FCJS-ECO will be controlled together. Devices will dim to the same level as the result of a control command. For more detail on adjusting low-end light level refer to Application Note#556 at [www.lutron.com](http://www.lutron.com).
- For the Line/Hot (L/H) terminal on the driver, it is preferred not to use the switched hot (red) wire from the control but rather the hot wire directly from the power source.
- Recommended for EasySense System.

# CUBE2-HC90

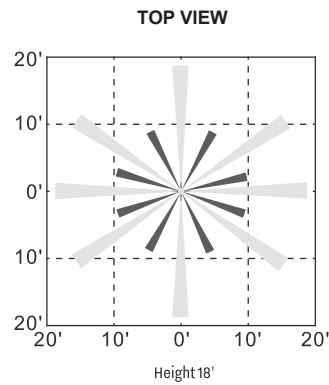
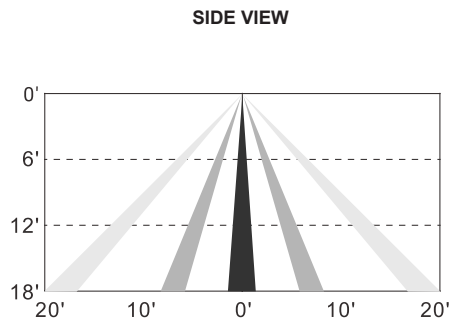
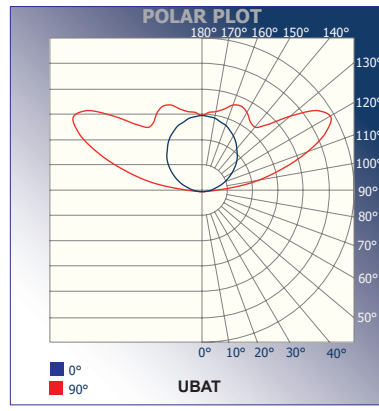
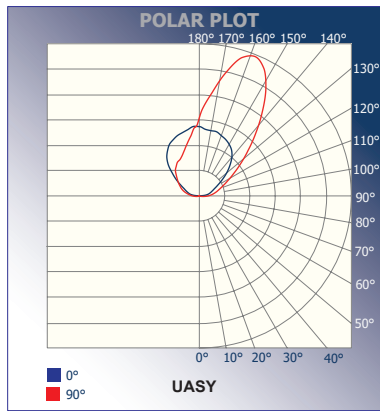
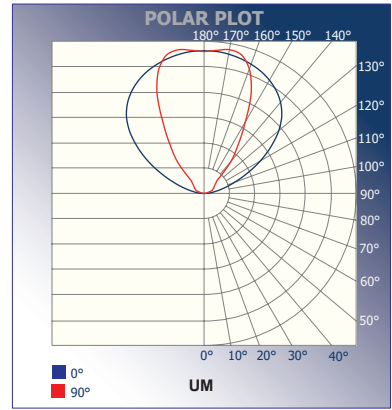
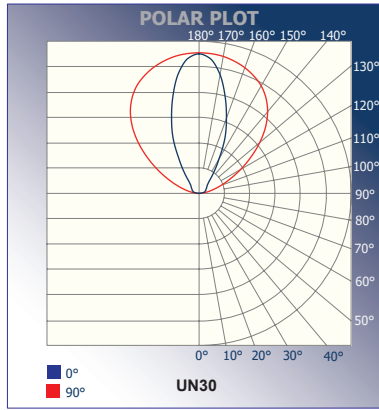
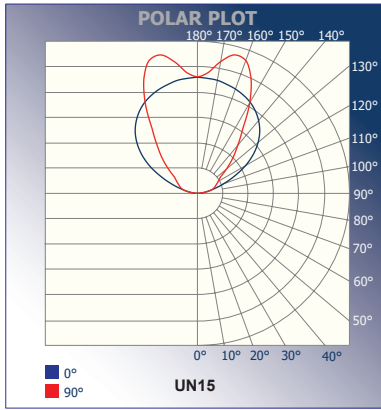

AMS, IFS105SE coverage pattern

# ARCHITECTURAL DESIGN

## CUBE2-HC90 LIT CONNECTOR PATTERNS

The lit connector system allows continuous illumination all the way through the corner section.

**Instruction:**

- Please provide sketches illustrating corner types, overall dimensions including corner dimensions, and locations required.
- HC90, TC, and XC connectors are 90 degree corners (overall, outside dimension).

