

CUBE4-CW90

Project Name:	
Type:	

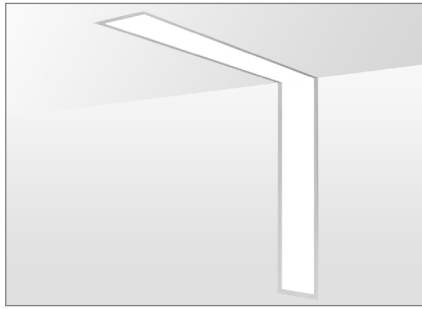

APPLICATION

The unique CUBE-CW90 series offer versatile installation from wall to ceiling or ceiling to wall. This seamless 90° luminaire creates endless transverse runs and provides flexibility in uniting a space with lines of light. CUBE-CW90 is well designed for commercial hallway, building lobby, educational environments, office, retail, or anywhere to add visual appeal along the ceiling to wall line.

MOUNTING:

- Compatible only with drywall.

LED:

- High quality array LEDs.
- LM80
- Color Temperature: 2700/3000/3500/4000/5000 (K).
- Color Rendering Index: >80 (optional >90).
- Nominal Lamp Life: 100,000 hours.
- Reported L70 hours: +60,000 (55°C).

ELECTRICAL:

- High power factor electronic driver, operate from a 120 ~ 277 Vac input range, 50 / 60 Hz.
- Features included over voltage protection, surge, short circuit protection and over load protection.
- Power Factor: typical > 0.95, THD <20, meets Class1 or Class 2 circuit.
- 0-10V dimmable driver as standard.
- 0-10VDC dimming 1%~100%.
- Operating temperature: -4°F (-20°C) ~ 122°F (50°C).

FINISH:

- Standard powder-coat textured white painted finish on exposed trim, consult factory for custom colors.
- Comes with snap-in acrylic lens as standard.

LISTING:

- UL / CUL listed.
- Listed to UL 1598 and UL 8750.
- UL listed for dry & damp location.
- CEC Compliant EM (please contact for more information)
- Assembled in USA (optional).
- BAA compliant (optional).
- 5 years limited warranty.
- 7 or 10 years limited warranty. (optional) ⁹
- Bluetooth Mesh System available, please contact factory for more information.

- <ELCU-200>
- Guarantees emergency lighting remains ON or is turned on when power to the control device is lost.
- Interfaces with fire alarm panel or security system.
- "Watchdog" feature allows emergency loads to be controlled in tandem with normal power loads.
- UL listed for use in emergency circuits.

CONFIGURATIONS

Series	Size	Model #	AC Input	Lumen Output		Lumen Efficiency
CUBE4	2'	18L	9.9W	1209.58 lm (100%)	1209.6 lm	122.18 lm/W
		27L	14.85W	1868.7 lm (100%)	1868.7 lm	125.84 lm/W
		36L	19.8W	2482.1 lm (100%)	2482.1 lm	125.36 lm/W
		48L	26.4W	3073.65 lm (100%)	3073.65 lm	116.4 lm/W
		54L	29.7W	3507.57 lm (100%)	3507.57 lm	118.10 lm/W
	3'	18L	14.85W	1814.3 lm (100%)	1814.3 lm	122.18 lm/W
		27L	22.27W	2802.45 lm (100%)	2802.45 lm	125.84 lm/W
		36L	29.7W	3723.19 lm (100%)	3723.19 lm	125.36 lm/W
		48L	39.6W	4610.48 lm (100%)	4610.48 lm	116.4 lm/W
		54L	44.55W	5261.3 lm (100%)	5261.3 lm	118.10 lm/W
	4'	18L	19.8W	2419.2 lm (100%)	2419.2 lm	122.18 lm/W
		27L	29.7W	3737.5 lm (100%)	3737.5 lm	125.84 lm/W
		36L	39.6W	4964.4 lm (100%)	4964.4 lm	125.36 lm/W
		48L	52.8W	6147.4 lm (100%)	6147.4 lm	116.4 lm/W
		54L	59.4W	7015.7 lm (100%)	7015.7 lm	118.10 lm/W
	6'	18L	29.7W	3628.7 lm (100%)	3628.7 lm	122.18 lm/W
		27L	44.55W	5606.1 lm (100%)	5606.1 lm	125.84 lm/W
		36L	59.4W	7446.38 lm (100%)	7446.38 lm	125.36 lm/W
		48L	79.2W	9220.96 lm (100%)	9220.96 lm	116.4 lm/W
		54L	89.1W	10522.71 lm (100%)	10522.71 lm	118.10 lm/W
	8'	18L	39.6W	4838.3 lm (100%)	4838.3 lm	122.18 lm/W
		27L	59.4W	7474.89 lm (100%)	7474.89 lm	125.84 lm/W
		36L	79.2W	9928.5 lm (100%)	9928.5 lm	125.36 lm/W
		48L	105.6W	12294.6 lm (100%)	12294.6 lm	166.4 lm/W
54L		118.8W	14030.28 lm (100%)	14030.28 lm	118.10 lm/W	

OUTPUT CURRENT

		Bi-Level		Tri-Level (Default)	
SW1	SW2	Config Range	Default	Config Range	Default
Close	Open	10% - 70%	40%	10% - 70%	30%
Open	Close	10% - 70%	40%	10% - 70%	70%
Close	Close	100%	100%	100%	100%
Open	Open	0%	0%	0%	0%

WEIGHT

Item	lbs	kg
CUBE 4 2FT DRYWALL	9.49	4.31
CUBE 4 3FT DRYWALL	13.54	6.14
CUBE 4 4FT DRYWALL	16.89	7.66
CUBE 4 8FT DRYWALL	30.52	13.85

ORDERING INFORMATION

EXAMPLE: CUBE4-10C7W-C4/4/2W3/4-D27L-40K-FT-UNV-STB

MODEL	ROW	SECTION	LED Downlight (per/4ft section)	COLOR TEMP.
CUBE4	x'C x'W * Specify nominal overall row length in 1' increments for continuous runs * 2' minimum for individual	C_/_/_... W_/_/_... * Ceiling from horizontal left -> right, wall from vertical top -> bottom * Specify each run in 2/3/4/6/8' run, otherwise factory will decide	D18L 18W LED D27L 27W LED D36L 36W LED D54L 54W LED	-27K 2700K -30K 3000K -35K 3500K -40K 4000K -50K 5000K
* Number of circuit(s) should be determined by the customer prior to ordering the continuous run considering the AC input voltage and total run wattage.		* Maximum wattage per 4ft section * Contact factory for custom wattage or lumen requirement.		

CRI	MOUNTING	VOLTAGE	EM SECTION ¹	HOUSING BRACKET	FINISH	
(Blank) C9	80+ CRI 90+ CRI ⁵ FT SF	Standard 1/2" Flange ¹¹ Spackle Flange (Trimeless) ¹¹	UNV 120 120V 277 277V 347 347V ¹²	(Blank) None EM 1SE 1 Section 2SE 2 Section xSE x Section	STB Slip Through Bracket ¹¹	(Blank) Matte White RAL #9003 (Std.) *BK Black RAL #9011 *SV Silver (RAL #9022) **CC Custom Color ⁸ *CSS Custom Canopy Color (White is Std.) *AMB Anti-Microbial Coating (Matte Skye White) * Non-standard finish with extra charge. ** CC: additional charge & set up fee. Provide RAL# code.

LED DRIVER	
(Blank) ES566 SD40 SDXX PHSR PHDL ED560 TDM TD30/70 TDXX/YY	0-10V dim to 1% (Std.) (dim both uplight and downlight simultaneously) eldoLED SOLODrive Natural Dimming to dark, 0-10V, 100% ~ 0.1% dim 40% / 100% Bi-Level Step dim XX% / 100% Bi-Level Step dim (Specify XX : 10% ~ 70%) Philips Xitanium Sensor-Ready, Dali 5%~100% dim. Philips Xitanium DALI driver, Dim to 5% eldoLED LightShape DALI dim to dark, 0.1% ~ 100% Triac Dim. (120V only) 30% / 70% / 100% Tri-Level Step dim XX% / YY% / 100% Tri-Level Step dim (Specify XX, YY : 10% ~ 70%)
LDE1 ELV TRIOT	Hi-Lume 1% EcoSystem LED driver with Soft-on, Fade-to-Black dimming technology, 100% ~ 1% dim ELV compatible (reverse-phase or trailing-edge), (120V only) Tridonic IoT ready, 1-100% dim via Smart Module Interface (SMI), automated dimming/lighting controls via Enlighted Sensor Interface 0-10V DIM-TO-OFF
DTO DMX DLM LTEA2W	DMX512 control system (Only available with RGB+W option) Wattstopper's DLM interface (Only available with RGB+W option) Hi-Lume 1% 2-wire LED driver (120V forward phase only)
BLT	Bluetooth Mesh System (contact factory for more information)

OPTIONS	LIGHTING CONTROL SYSTEM
EMG8 EMG15 EMG20 EMG25 ELCU-200 GTD GTD10DIM GLR GMF ARRA BAA O7W O10W AMS DPMS SO LSR-301-S LSR-301-P E1F E2F	<p><Lutron VIVE System Enabled></p> <p>LUTRON VIVE  Click Here!</p> <p><EasySense></p> <p>SNS200 EasySense Fixture-mount occupancy sensing, daylight harvesting and task tuning in one device (Must be ordered with PHSR driver) ^{6,9}</p> <p>RS-IR IR dongle v2.0 for EasySense control</p> <p><Enlighted></p> <p>SU-5E Enlighted IoT ready 0-10V Indoor Micro sensor with occupancy/vacancy detection, daylight harvesting, thermal sensing, task tuning, and room and zone control, Bluetooth enabled (Must be ordered with TRIOT) ⁷</p> <p>RS-WS Enlighted Room controller providing basic control functions of a standard wall switch with preset dimming capability</p> <p><Bluetooth></p> <p>IFS105SE Bluetooth Mesh Wireless Sensor. Occupancy/Daylight/0-10V Dimming</p> <p>PPA102S Bluetooth Powerpack (Consult factory for installation location)</p>
1296 LUMEN EM Battery Backup (CEC Compliant EM) ⁴	
2430 LUMEN EM Battery Backup (CEC Compliant EM) ⁴	
3240 LUMEN EM Battery Backup (CEC Compliant EM) ⁴	
4050 LUMEN EM Battery Backup (CEC Compliant EM) ⁴	
Fail-to-on Emergency lighting, UL924 ¹⁰	
Bodine Generator Transfer Device	
Bodine Generator Transfer Device (0-10VDC Dimmer Override)	
Fast Blow Fuse ¹³	
Slow Blow Fuse ¹³	
Assembled in USA for Buy American Act	
BAA(Buy American Act) and BABA(Build America Buy America) compliant	
Optional 7 Years Limited Warranty ²	
Optional 10 Years Limited Warranty ²	
Bluetooth Mesh Wireless Sensor. Occupancy/Daylight/0-10V Dimming	
Daylight Dimming Photo Sensor (0-10 VDC Control), (LSR-301-S required if FD-301 is installed) ¹⁴	
Dimming Wires connected to Sensor Only (available option on FS-205 non-Bluetooth AMS sensor only) ³	
Setup Remote Control for DPMS (Required for DPMS)	
Occupant Remote Control for DPMS	
End feed on one end (Pre-drilled hole for 1/2" fitting)	
End feed on both ends (Pre-drilled holes for 1/2" fitting)	

NOTES:

- EM is installed in last 4' of luminaire sections. Separate section required 2SE or specified. Must specify voltage, not available with 347V.
- This limited warranty covers electrical parts only and does not apply to labor, equipment lease, or defect from improper installation or operation.
- Dimming wires provided and connected to sensor only, not for dimmer switch. (available with AMS and DPMS option)
- Contact factory for other emergency ballast options.
- Lumen per watt is around 15% less than standard CRI (80+).
- See NFC and IR manual in the separate attachment. If your phone is not compatible, please order "RS-IR" and follow the manual.
- "RS-WS" option can be added if wish to have a wall switch, please see Enlighted Room Controller in the separate attachment.
- Refer to color charts (RAL and/or Cardinal) in the separate attachment.
- Refer to Advanced Grouping Datasheet for its default setting and compatible wireless switches.
- Standard with "FT" and "SF" mounting.
- Requires "STB" as standard.
- 347V cannot work with Emergency Battery Backup.
- Must specify voltage, not available with 347V.
- Automatic on/off is not available. For automatic on/off, additional occupancy sensor is required or a manual on/off switch can be done.

CUBE4-SF

All dimensions are in inches (millimeters).

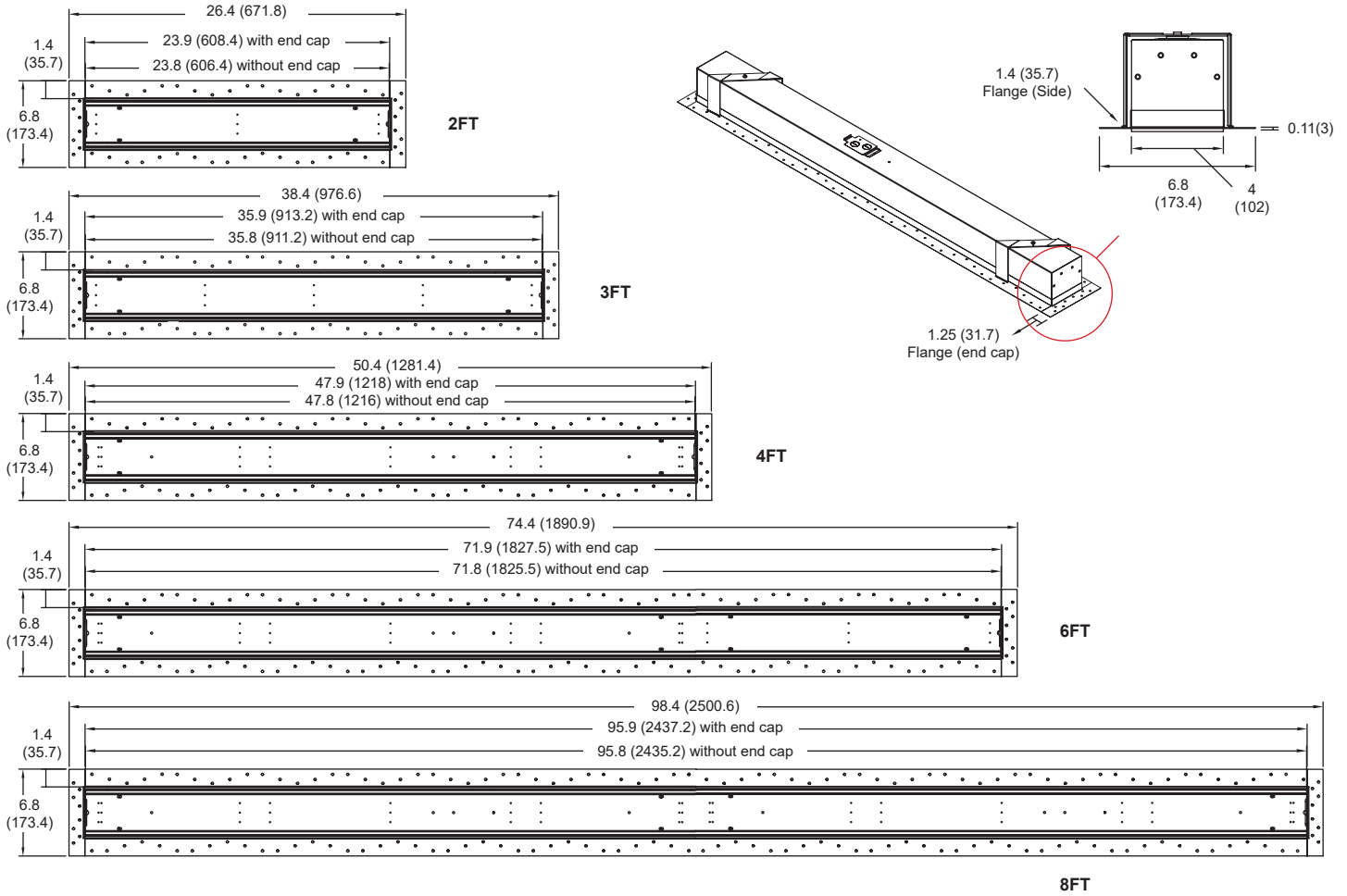

CUBE4-FT

All dimensions are in inches (millimeters).

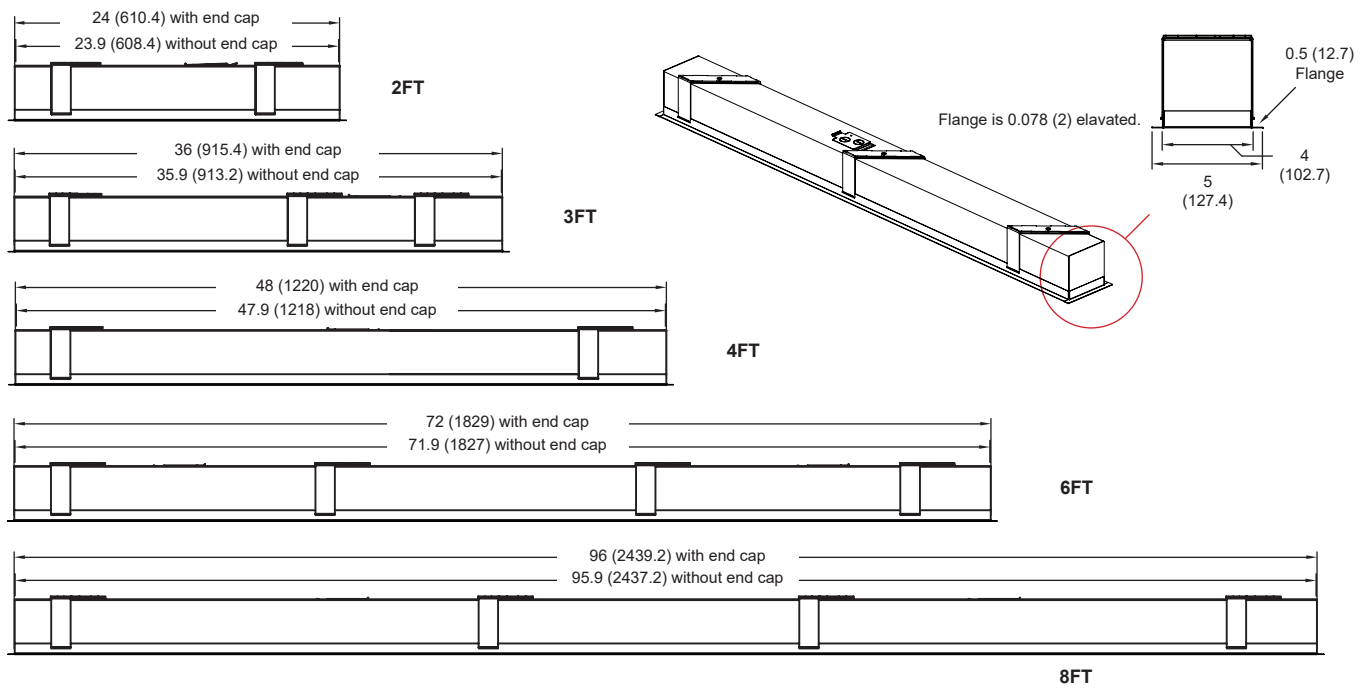

CUBE4-CW90

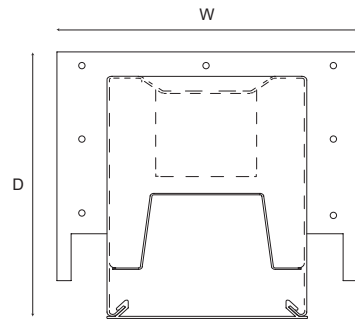

Specifications: CUBE4

Width: 4 (101)
Depth: 4 (101)

All dimensions are in inches (millimeters).

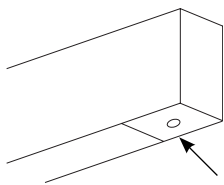

Sensor Plate



Lutron Vive Integral
fixture control installation



EasySense
fixture-mount installation

**- INACCESSIBLE
CEILING MOUNTING**

Flange Detail

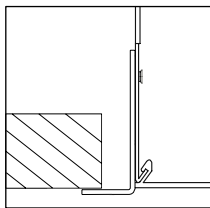

Exposed Flange Detail:
Specify FT in part #

- SPECIALTY MOUNTS

Rotating Crossbar

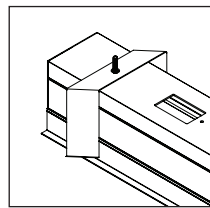

Unavailable Structure Support:
Specify STB in part #

SF
(Spackle Flange, Trimeless)

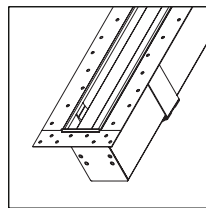

#STB in part is standard

CW90

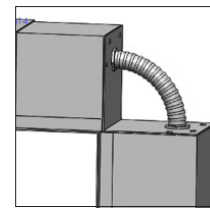

SIDE VIEW

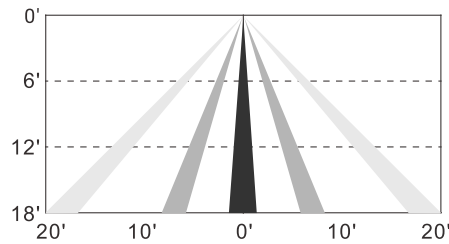

TOP VIEW

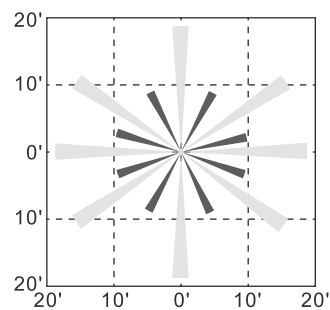

AMS, IFS105SE coverage pattern

CUBE4-CW90

COMPATIBLE DIMMER SWITCH (TABLE 1)

Model #	Brand	Compatible Dimmer Switch	
(Blank)	-	<Leviton>	IlumaTech IP7 series
		<Lutron>	Visit www.lutron.com/advance for a list of dimmers (Mark VII) that will work with this driver.
		<Philips>	Sunrise : SR1200ZTUNV
ES566	eldoLED SOLOdrive	<Busch-Jaeger>	2112U-101
		<Jung>	240-10
		<Leviton>	IlumaTech - IP710-DLX
		<Lightoller Controls>	ZP600FAM120
		<Merten>	5729
		<Pass & Seymour>	CD4FB-W
		<Wattstopper>	DCLV1
		<Sensor Switch>	nIO EZ
		<Synergy>	ISD BC
		<ABB>	SD/S 2.16.1
		<Lutron>	Nova T: NTFTV Diva - DVTV-xx, NFTV GRAFIK Eye: GRX-TV1 w GRX3503 Energy Savr Node: QSN-4T16-S TVM2 Module
		<Crestron>	GLX-DIMFLV8, GLXP-DIMFLV8, GLPAC-DIMFLV4-*, GLPAC-DIMFLV8-*, GLPP-DIMFLVEX-PM, GLPP-1DIMFLV2EX-PM, GLPP-1DIMFLV3EX-PM, DIN-AO8, DIN-4DIMFLV4, CLS-EXP-DIMFLV, CLCI-1DIMFLV2EX
		ED560	eldoLED DUALdrive
LDE1	Lutron Hi-lume 1% EcoSystem	<Lutron>	PowPak Dimming Modules: RMJ-ECO32-DV-B, FCJ/FCJS-ECO 1,2 Energi Savr Node (120V only): QSN-1ECO-S, QSN-2ECO-S GRAFIK Eye QS/Homeworks QS control unit (120V only): QSGRJ-_E(wireless) QSGR-_E Quantum Hub (120V only): QP2-_2C/4C/6C/8C Homeworks QS/myRoom Plus power module (120V only): LQSE-2ECO-D
PHSR 3	Philips Xitanium Sensor-Ready	<Ilumra>	<u>Single Rocker Self-Powered Light Switch (on/off, dim-up/down)</u> Ilumra# ZBT-S1AWH Digi-Key# 1082-1033-ND <u>Dual Rocker Self-Powered Light Switch (on/off, dim-up/down, scene1,2)</u> Ilumra# ZBT-S2AWH Digi-Key# 1082-1034-ND
TDM	KEYSTONE	<Lutron>	Diva DV-600P, SkyLark S-600P, Ariadni AY-600P, Ariadni TG-603P, Maestro MA-600 (Digital), Diva CFL/LED DVCL-153P, Satin Colors DVSC-600P-SW
		<Leviton>	6641, IlumaTech IPI06-1LX, ToggleTouch TGI06-1LW (Digital)
ELV	KEYSTONE	<Lutron>	MAELV-600BL (Digital), DVELV-300P, SkyLark SELV-300P
DTO	Philips Xitanium Gen.2 Philips Xitanium Sensor-Ready	<Lutron>	Nova T: #NTSTV-DV http://www.lutron.com/TechnicalDocumentLibrary/NovaTB.pdf See page13.
LTEA2W	Lutron Hi-lume 2-wire (120V forward voltage only)	<Lutron>	Visit http://www.lutron.com/TechnicalDocumentLibrary/369543_ENG.pdf for a list of compatible dimmer switches.

NOTES:

- All devices connected to one FCJ/FCJS-ECO will be controlled together. Devices will dim to the same level as the result of a control command. For more detail on adjusting low-end light level refer to Application Note#556 at www.lutron.com.
- For the Line/Hot (L/H) terminal on the driver, it is preferred not to use the switched hot (red) wire from the control but rather the hot wire directly from the power source.
- Recommended for EasySense System.

ARCHITECTURAL LINEAR

CUBE 2 LIT CONNECTOR PATTERNS

The lit connector system allows continuous illumination all the way through the corner section.

Instruction:

- Please provide sketches illustrating corner types, overall dimensions including corner dimensions, and locations required.
- HC90, TC, and XC connectors are 90 degree corners (overall, outside dimension).

