

CUBE2-NRC-HC90

Project Name:	
Type:	



APPLICATION

The CUBE2-NRC offers an easy integration of lighting and acoustic solutions. While the acoustic provides an acoustic solution to the source of noise for optimal sound absorption, seamlessly designed acoustic felt gives design flexibility and personalization for any application. Perfect for places in need to reduce reverberation such as open offices and lobbies, retails, hospitality, reception areas and corridors, and commercial interiors.

FEATURE:

- Luminaire is available in 90 or 135 degree shape.
- Sound absorbing linear direct acoustic LED luminaire.
- Material rated for NRC (Noise Reduction Coefficient) of 0.90.
- Acoustic felt is 100% virgin polyester and 0.5" thick.
- 45 degree deburr design is standard. Flushed design is available upon request.
- Available in 6" to 24" nominal housing heights in 2" increments.
- Wide range of felt color (2 standards and 18 premium) options available. Refer to the last page for color offering.

MOUNTING:

- Pendant mount.

LED:

- High quality array LEDs.
- LM80
- Color Temperature: 2700/3000/3500/4000/5000 (K).
- Color Rendering Index: >80 (optional>90).
- Nominal Lamp Life: 100,000 hours.
- Reported L70 hours: +60,000 (55°C).

ELECTRICAL:

- High power factor electronic driver, operate from a 120 ~ 277 Vac input range, 50 / 60 Hz.
- Features included over voltage protection, surge, short circuit protection and over load protection.
- Power Factor: typical > 0.95, THD <20, meets Class1 or Class 2 circuit.
- 0-10V dimmable driver as standard.
- 0-10VDC dimming 1%~100%.
- Operating temperature: -4°F (-20°C) ~ 122°F (50°C).

<ELCU-200>

- Guarantees emergency lighting remains ON or is turned on when power to the control device is lost.
- Interfaces with fire alarm panel or security system.
- "Watchdog" feature allows emergency loads to be controlled in tandem with normal power loads.
- UL listed for use in emergency circuits.

FINISH:

- Fixture is powder-coated in standard white finish.
- Comes with snap-in acrylic lens as standard.

LISTING:

- UL / CUL listed.
- Listed to UL 1598 and UL 8750.
- UL listed for dry & damp location.
- CEC Compliant EM (please contact for more information)
- Assembled in USA (optional).
- BAA compliant (optional).
- 5 years limited warranty.
- 7 or 10 years limited warranty. (optional) ⁹
- Bluetooth Mesh System available, please contact factory for more information.

CONFIGURATIONS

Series	Size	Model #	AC Input	Fixture Lumen Output (4000K)		Lumen Efficiency (4000K)
CUBE2-HC90	11	D18L	9.9W	1280.46 lm (100% Down)	1280.46 lm	129.34 lm/W
		D27L	14.85W	1641.66 lm (100% Down)	1641.66 lm	110.55 lm/W
		D36L	19.8W	2122.36 lm (100% Down)	2122.36 lm	107.19 lm/W
		D48L	26.4W	2811.6 lm (100% Down)	2811.6 lm	106.5 lm/W
		D54L	29.7W	3146.41 lm (100% Down)	3146.41 lm	105.94 lm/W
	12 & 21	D18L	14.85W	1921.29 lm (100% Down)	1921.29 lm	129.38 lm/W
		D27L	22.27W	2461.50 lm (100% Down)	2461.50 lm	110.53 lm/W
		D36L	29.7W	3182.95 lm (100% Down)	3182.95 lm	107.17 lm/W
		D48L	39.6W	4217.4 lm (100% Down)	4217.4 lm	106.5 lm/W
		D54L	44.55W	4720.51 lm (100% Down)	4720.51 lm	105.96 lm/W
	22	D18L	19.8W	2562.12 lm (100% Down)	2562.12 lm	129.40 lm/W
		D27L	29.7W	3283.33 lm (100% Down)	3283.33 lm	110.55 lm/W
		D36L	39.6W	4244.72 lm (100% Down)	4244.72 lm	107.19 lm/W
		D48L	52.8W	5623.2 lm (100% Down)	5623.2 lm	106.5 lm/W
D54L		59.4W	6294.02 lm (100% Down)	6294.02 lm	105.96 lm/W	
CUBE2-HC135	22	D18L	19.8W	2562.12 lm (100% Down)	2562.12 lm	129.40 lm/W
		D27L	29.7W	3283.33 lm (100% Down)	3283.33 lm	110.55 lm/W
		D36L	39.6W	4244.72 lm (100% Down)	4244.72 lm	107.19 lm/W
		D48L	52.8W	5623.2 lm (100% Down)	5623.2 lm	106.5 lm/W
		D54L	59.4W	6294.02 lm (100% Down)	6294.02 lm	105.96 lm/W

CCT	Multiplier		
	3000K	3500K	5000K
Down only	0.9642	0.9822	1.0357

OUTPUT CURRENT

SW1	SW2	Bi-Level		Tri-Level (Default)	
		Config Range	Default	Config Range	Default
Close	Open	10% - 70%	40%	10% - 70%	30%
Open	Close	10% - 70%	40%	10% - 70%	70%
Close	Close	100%	100%	100%	100%
Open	Open	0%	0%	0%	0%

CUBE2-NRC-HC90



Specifications: CUBE2-NRC

Width: 3.5 (88.9)
 Depth: MIN.6 (152.4)
 All dimensions are in inches (millimeters).

WEIGHT

Item	lbs	kg
CUBE2-HC90	15.19	6.89
CUBE2-HC135	17.37	7.88

ORDERING INFORMATION

EXAMPLE: CUBE2-NRC-HC90-12-D27L-30K-UNV-SL-X1-AC48

MODEL	Shape		Size	HEIGHT (heights are nominal)		LED Downlight (per/each section)		COLOR TEMP.		COLOR TEMP.		
CUBE2-NRC	HC90	90 Degree	11	1' x 1'	6	6" (Minimum)	D18L	18W LED	-30K	3000K ¹	(Blank)	80+ CRI
			12	1' x 2'	8	8"	D27L	27W LED	-35K	3500K	C9	90+ CRI ²
			21	2' x 1'	10	10"	D36L	36W LED	-40K	4000K		
			22	2' x 2'	12	12"	D54L	54W LED	-50K	5000K		
HC135	135 Degree	22	2' x 2'	XX	Custom Height, Max. 24" (2" increments)	* Maximum wattage per each section - 54W (down light)		* Contact factory for custom wattage or lumen requirement.				
CM	Custom pattern (must provide a sketch on the last page of this spec sheet)											

MOUNTING		VOLTAGE		EM SECTION ⁴		FINISH (FIXTURE)		FINISH (BAFFLE)		CORD FINISH	
(Blank)	Pendant	UNV	120-277V	(Blank)	None EM	(Blank)	Matte White RAL #9003 (Std.)	SL	Slate	(Blank)	White (Std.)
		120	120V	1SE	1 Section	*BK	Black RAL #9011	PW	Pewter	*BKC	Black
		277	277V	2SE	2 Section	*SV	Silver (RAL #9022)	CC	Premium Color (choose 2 letters from the last page)		
		347	347V ³	xSE	x Section	**CC	Custom Color ¹⁶				
						*AMB	Anti-Microbial Coating (Matte Skye White)				
							* Non-standard finish with extra charge.				* Non-standard finish with extra charge.
							** Additional charge & set up fee.				** Additional charge & set up fee.

CANOPY FINISH		CEILING TYPE		SUSPENSION LENGTH		DRIVER						
(Blank)	White (Std.)	X1	T-bar ceiling	AC48	Adjustable Aircraft Cable Canopy 48"L	(Blank)	0-10V dim to 1% (Std.) (dim both upright and downlight simultaneously)					
*BC	Black Canopy	X2	Hard ceiling	AC96	Adjustable Aircraft Cable Canopy 96"L	ES566	eldoLED SOLOdrive Natural Dimming to dark, 0-10V, 100% ~ 0.1% dim					
*SC	Silver Canopy	X3	Sloped Hard ceiling	ST24	Stem Canopy 24"L	SD40	40% / 100% Bi-Level Step dim					
**CSS	Custom Canopy Color (White is Std.)			ST48	Stem Canopy 48"L	SDXX	XX% / 100% Bi-Level Step dim (Specify XX : 10% ~ 70%)					
						PHSR	Philips Xitanium Sensor-Ready, Dali 5%~100% dim.					
						PHDL	Philips Xitanium DALI driver, Dim to 5%					
						TDM	Triac Dim. (120V only)					
						TD30/70	30% / 70% / 100% Tri-Level Step dim					
						TDXX/YY	XX% / YY% / 100% Tri-Level Step dim (Specify XX, YY : 10% ~ 70%)					
						LDE1	Hi-lume 1% EcoSystem LED driver with Soft-on, Fade-to-Black dimming technology, 100% ~ 1% dim					
						ELV	ELV compatible (reverse-phase or trailing-edge), (120V only)					
						TRIOT	Tridonic IoT ready, 1-100% dim via Smart Module Interface (SMI), automated dimming/lighting controls via Enlighted Sensor Interface					
						DTO	0-10V DIM-TO-OFF					
						LTEA2W	Hi-lume 1% 2-wire LED driver (120V forward phase only) ²⁰					
						BLT	Bluetooth Mesh System (contact factory for more information)					

OPTIONS		LIGHTING CONTROL SYSTEM	
EMG8	1296 LUMEN EM Battery Backup (CEC Compliant EM) ^{5,6}	LUTRON VIVE	<u><Lutron Vive System Enabled></u>
EMG15	2430 LUMEN EM Battery Backup (CEC Compliant EM) ^{5,6}		 Click Here!
EMG20	3240 LUMEN EM Battery Backup (CEC Compliant EM) ^{5,6}		<u><EasySense></u>
EMG25	4050 LUMEN EM Battery Backup (CEC Compliant EM) ^{5,6}		SNS200 EasySense Fixture-mount occupancy sensing, daylight harvesting and task tuning in one device (Must be ordered with PHSR driver) ^{12,13}
ELCU-200	Fail-to-on Emergency lighting, UL924 ⁷		RS-IR IR dongle v2.0 for EasySense control
F1	Single Fuse for 120/277/347V ⁸		<u><Enlighted></u>
F2	Double Fuse for 208/240V ⁸		SU-5E Enlighted IoT ready 0-10V Indoor Micro sensor with occupancy/vacancy detection, daylight harvesting, thermal sensing, task tuning, and room and zone control, Bluetooth enabled (Must be ordered with TRIOT) ¹⁴
ARRA	Assembled in USA for Buy American Act		RS-WS Enlighted Room controller providing basic control functions of a standard wall switch with preset dimming capability
BAA	BAA(Buy American Act) and BABA(Build America Buy America) compliant		<u><Bluetooth></u>
O7W	Optional 7 Years Limited Warranty ⁹		IFS105SE Bluetooth Mesh Wireless Sensor. Occupancy/Daylight/0-10V Dimming
O10W	Optional 10 Years Limited Warranty ⁹		PPA102S Bluetooth Powerpack (Consult factory for installation location)
AMS	Bluetooth Mesh Wireless Sensor. Occupancy/Daylight/0-10V Dimming		
DPMS	Daylight Dimming Photo Sensor (0-10 VDC Control), (LSR-301-S required if FD-301 is installed) ¹¹		
SO	Dimming Wires connected to Sensor Only (available option on FS-205 non-Bluetooth AMS sensor only) ¹⁰		
LSR-301-S	Setup Remote Control for DPMS (Required for DPMS)		
LSR-301-P	Occupant Remote Control for DPMS		

NOTES:

- Available with C9 (CRI 90+) only.
- Lumen per watt is around 15% less than standard CRI (80+).
- 347V not available with Emergency Battery Backup.
- EM is installed in last 4' of luminaire sections. Separate section requires 2SE or specified.
- Contact factory for other emergency battery backup options.
- For individual piece order, remote EM is provided due to limited space.
- Shipped separately.
- Must provide voltage.
- This limited warranty covers electrical parts only and does not apply to labor, equipment lease, or defect from improper installation or operation.
- Dimming wires provided and connected to sensor only, not for dimmer switch.
- Automatic on/off is not available. For automatic on/off, additional occupancy sensor is required or a manual on/off switch can be done.
- See NFC and IR manual in the separate attachment. If your phone is not compatible, please order "RS-IR" and follow the manual.
- Refer to Advanced Grouping Datasheet for its default setting and compatible wireless switches.
- "RS-WS" option can be added if wish to have a wall switch, please see Enlighted Room Controller in the separate attachment.

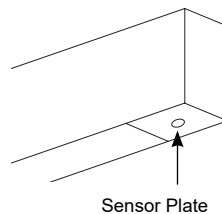
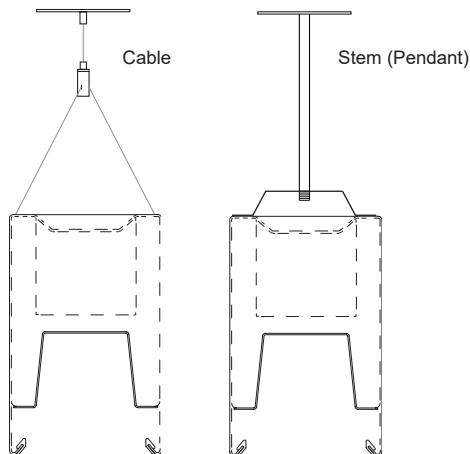

Lutron Vive Integral fixture control installation



EasySense fixture-mount installation

CUBE2-NRC-HC90

Dimensions

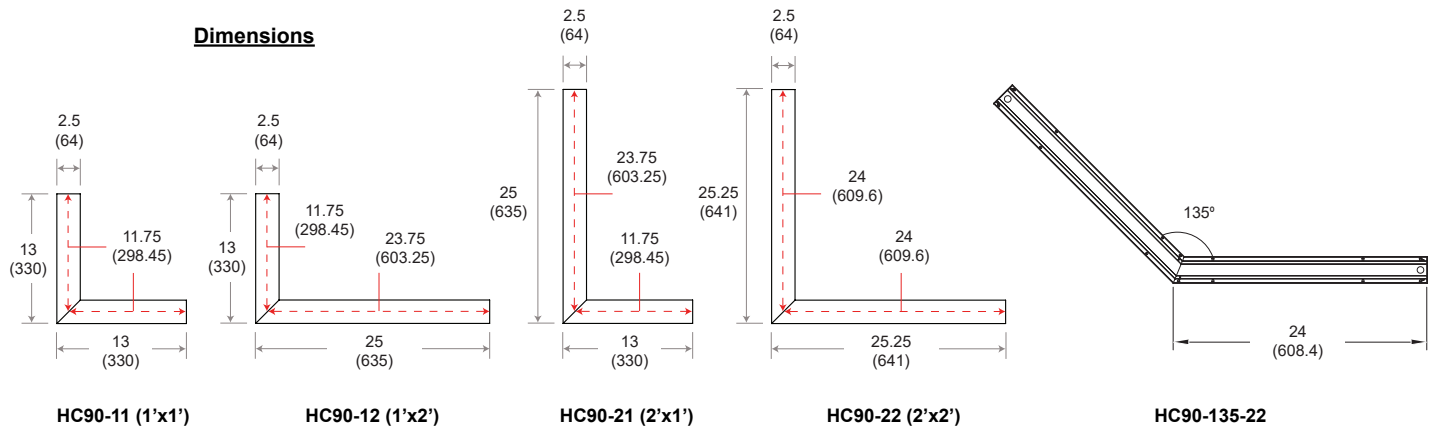

Mounting

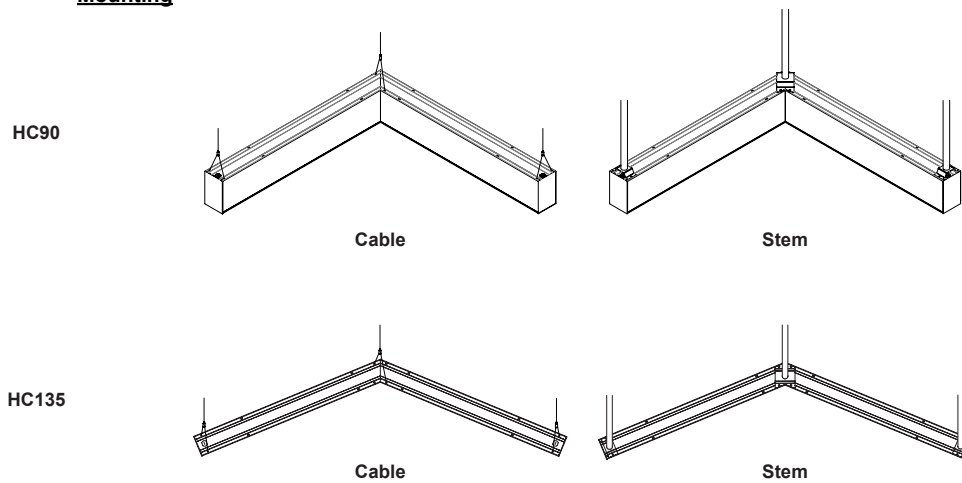

SIDE VIEW

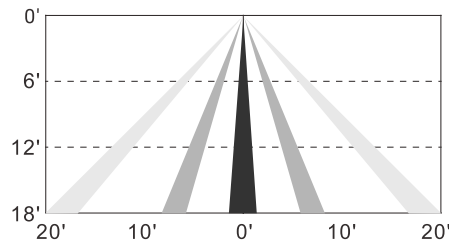

TOP VIEW

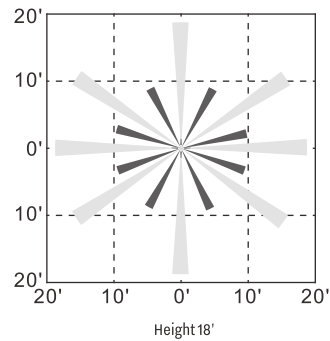

AMS, IFS105SE coverage pattern

COMPATIBLE DIMMER SWITCH (TABLE 1)

Model #	Brand	Compatible Dimmer Switch	
(Blank)	-	<Leviton>	IP710-LFZ
		<Lutron>	Visit www.lutron.com/advance for a list of dimmers (Mark VII) that will work with this driver.
ES566	eldoLED SOLOdrive	<Busch-Jaeger>	2112U-101
		<Jung>	240-10
		<Leviton>	IlumaTech - IP710-DLX
		<Lightoller Controls>	ZP600FAM120
		<Merten>	5729
		<Pass & Seymour>	CD4FB-W
		<Wattstopper>	DCLV1
		<Sensor Switch>	nIO EZ
		<Synergy>	ISD BC
		<ABB>	SD/S 2.16.1
		<Lutron>	Nova T: NTFTV Diva - DVTV-xx, NFTV GRAFIK Eye: GRX-TV1 w GRX3503 Energy Savr Node: QSN-4T16-S TVM2 Module
<Crestron>	GLX-DIMFLV8, GLXP-DIMFLV8, GLPAC-DIMFLV4-*, GLPAC-DIMFLV8-*, GLPP-DIMFLVEX-PM, GLPP-1DIMFLV2EX-PM, GLPP-1DIMFLV3EX-PM, DIN-AO8, DIN-4DIMFLV4, CLS-EXP-DIMFLV, CLCI-1DIMFLV2EX		
LDE1	Lutron Hi-Lume 1% EcoSystem	<Lutron>	PowPak Dimming Modules: RMJ-ECO32-DV-B, FCJ/FCJS-ECO ^{1,2} Energi Savr Node (120V only): QSN-1ECO-S, QSN-2ECO-S GRAFIK Eye QS/Homeworks QS control unit (120V only): QSGRJ- E(wireless) QSGR- E Quantum Hub (120V only): QP2- _2C/4C/6C/8C Homeworks QS/myRoom Plus power module (120V only): LQSE-2ECO-D
PHSR ³	Philips Xitanium Sensor-Ready	<Ilumra>	<u>Single Rocker Self-Powered Light Switch (on/off, dim-up/down)</u> Ilumra# ZBT-S1AWH Digi-Key# 1082-1033-ND <u>Dual Rocker Self-Powered Light Switch (on/off, dim-up/down, scene1.2)</u> Ilumra# ZBT-S2AWH Digi-Key# 1082-1034-ND
TDM	KEYSTONE	<Lutron>	Diva DV-600P, SkyLark S-600P, Ariadni AY-600P, Ariadni TG-603P, Maestro MA-600 (Digital), Diva CFL/LED DVCL-153P, Satin Colors DVSC-600P-SW
		<Leviton>	6641, IlumaTech IPI06-1LX, ToggleTouch TGI06-1LW (Digital)
ELV	KEYSTONE	<Lutron>	MAELV-600BL (Digital), DVELV-300P, SkyLark SELV-300P
DTO	Philips Xitanium Gen.2 Philips Xitanium Sensor-Ready	<Lutron>	Nova T: #NTSTV-DV http://www.lutron.com/TechnicalDocumentLibrary/NovaTB.pdf See page13.
LTEA2W	Lutron Hi-Lume 2-wire (120V forward voltage only)	<Lutron>	Visit http://www.lutron.com/TechnicalDocumentLibrary/369543_ENG.pdf for a list of compatible dimmer switches.

NOTES:

- All devices connected to one FCJ/FCJS-ECO will be controlled together. Devices will dim to the same level as the result of a control command. For more detail on adjusting low-end light level refer to Application Note#556 at www.lutron.com.
- For the Line/Hot (L/H) terminal on the driver, it is preferred not to use the switched hot (red) wire from the control but rather the hot wire directly from the power source.
- Recommended for EasySense System.

NRC COMPARISON

Frequency/Hz	100	125	160	200	250	315	400	500	630	800	1000	1250	1600	2000	2500	3150	4000	ā	NRC
0mm / 0"	0.03	0.01	0.09	0.04	0.05	0.09	0.12	0.25	0.32	0.49	0.61	0.72	0.82	0.85	0.91	0.94	0.95	0.44	0.45
50mm / 2"	0.20	0.16	0.22	0.32	0.46	0.56	0.63	0.80	0.89	1.03	1.04	0.99	1.07	1.00	0.93	0.87	0.92	0.81	0.80
150mm / 6"	0.29	0.46	0.44	0.57	0.68	0.81	0.97	0.96	0.91	1.04	0.92	0.80	0.94	0.94	0.91	0.90	0.91	0.97	0.90

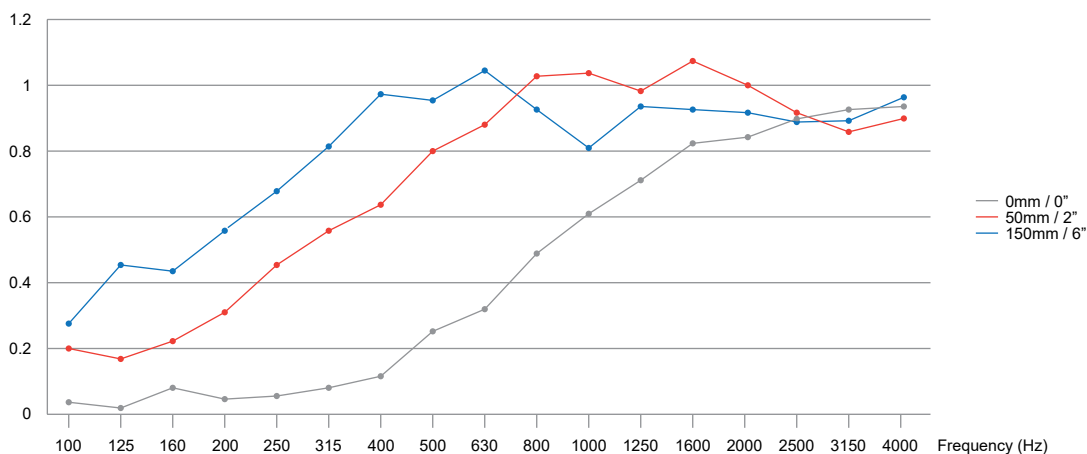

CUBE2-NRC-HC90

<STANDARD>

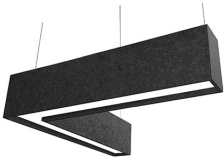

SL: SLATE

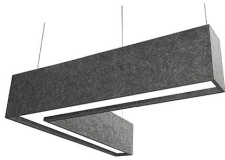

PW: PEWTER

<PREMIUM>

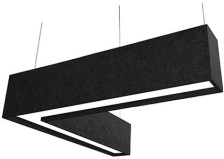

TR: TAR

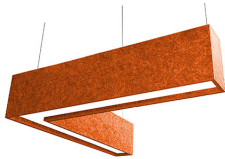

MD: MANDARIN

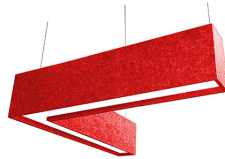

OC: OCHRE

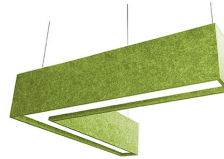

GR: GRASS

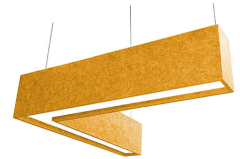

SS: SUNSHINE

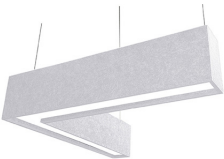

FR: FROST



IV: IVORY

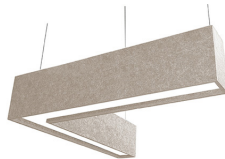

LN: LINEN



EC: ECRU



BR: BARK

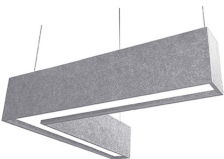

CH: CHAMBARY

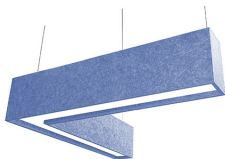

SK: SKY

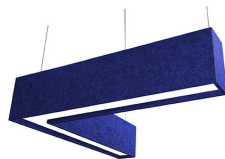

CB: COBALT

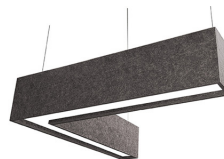

FO: FOSSIL

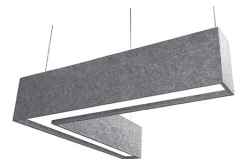

GE: GREIGE

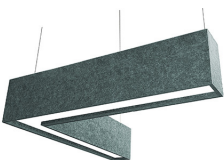

CD: CADET

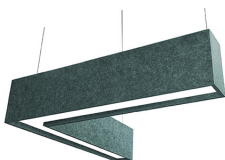

MC: MALACHITE

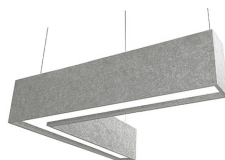

SM: SMOKE

1. Standard finish is free of charge.
2. Premium finish with extra charge. Please contact factory for more information.

ARCHITECTURAL ACOUSTIC 90°/135° DESIGN

CUBE2-NRC-HC90 LIT CONNECTOR PATTERNS

The lit connector system allows continuous illumination all the way through the corner section.

Instruction:

- Please provide sketches illustrating corner types, overall dimensions including corner dimensions, and locations required.
- HC90, TC, and XC connectors are 90 degree corners (overall, outside dimension).

