

CUBE2-X

Project Name:	
Type:	

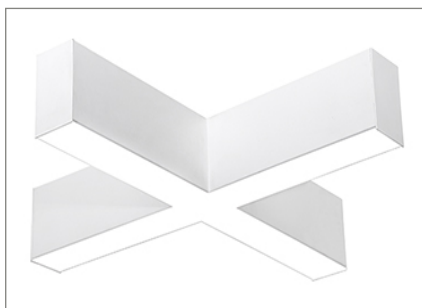

APPLICATION

The CUBE2-X creates a design statement for contemporary and traditional architectural interiors. The 90 degree luminaires are decorative and suitable for a multiple of applications like offices, retails, museums and galleries as well as high ceiling application such as lobbies.

FEATURE:

- Housing is formed by cold-rolled steel with a highly reflective die-formed white painted steel reflector.
- The snap-in acrylic lens has a matte finish and a diffuser (.125" thick) which is removable for lamp replacement.

MOUNTING:

- Pendant and drywall mount available.

LED:

- High quality array LEDs.
- LM80
- Color Temperature: 3000/3500/4000/5000 (K)
- Color Rendering Index: > 80 (optional>90).
- Nominal Lamp Life: 100,000 hours.
- Reported L70 hours: +60,000 (55°C).

ELECTRICAL:

- High power factor electronic driver, operate from a 120 ~ 277 Vac input range, 50 / 60 Hz.
- Features included over voltage protection, surge, short circuit protection and over load protection.
- Power Factor: typical > 0.95, THD <20, meets Class1 or Class 2 circuit.
- 0-10V dimmable driver as standard.
- 0-10VDC dimming 1%~100%.
- Operating temperature: -4°F (-20°C) ~ 122°F (50°C).

<ELCU-200>

- Guarantees emergency lighting remains ON or is turned on when power to the control device is lost.
- Interfaces with fire alarm panel or security system.
- "Watchdog" feature allows emergency loads to be controlled in tandem with normal power loads.
- UL listed for use in emergency circuits.

FINISH:

- Standard powder-coat textured white painted finish on exposed trim, consult factory for custom colors.
- Comes with snap-in acrylic lens as standard.

LISTING:

- UL / CUL listed.
- Listed to UL 1598 and UL 8750.
- UL listed for dry & damp location.
- Assembled in USA (optional).
- BAA compliant (optional).
- 5 years limited warranty.
- 7 or 10 years limited warranty. (optional) ⁵
- Bluetooth Mesh System available, please contact factory for more information.

CONFIGURATIONS

Series	Model #	AC Input	Fixture Lumen Output (4000K)		Lumen Efficiency (4000K)	
CUBE2-X	18L	19.8W	2562.12 lm (100% Down)	2562.12 lm	129.40 lm/W	
	27L	29.7W	3283.33 lm (100% Down)	3283.33 lm	110.55 lm/W	
	36L	39.6W	4244.72 lm (100% Down)	4244.72 lm	107.19 lm/W	
	48L	49.8W	5303.70 lm (100% Down)	5303.70 lm	106.5 lm/W	
	54L	57W	5849 lm (100% Down)	5849 lm	105.96 lm/W	
	18L/18L	39.6W	2358.73 lm (57.6% Down) / 1736.30 lm (42.4% Up)		4095.03 lm	103.41 lm/W
	27L/18L	49.5W	3303.73 lm (63% Down) / 1940.30 lm (37% Up)		5244.03 lm	105.94 lm/W
	27L/27L	59.4W	3538.10 lm (57.6% Down) / 2604.45 lm (42.4% Up)		6142.55 lm	103.41 lm/W
	36L/18L	59.4W	3954.11 lm (65.5% Down) / 2082.71 lm (34.5% Up)		6036.82 lm	101.63 lm/W
	48L/18L	69.6W	4569.44 lm (64.6% Down) / 2504 lm (35.4% Up)		7073.44 lm	101.63 lm/W
	48L/27L	79.5W	4791.19 lm (59.3% Down) / 3288.39 lm (40.7% Up)		8079.58 lm	101.63 lm/W
	54L/18L	76.8W	5697.78 lm (73% Down) / 2107.4 lm (27% Up)		7805.18 lm	101.63 lm/W

CCT	Multiplier		
	3000K	3500K	5000K
Down only	0.9642	0.9822	1.0357
Up&Down	0.971	0.9856	1.029

OUTPUT CURRENT

SW1	SW2	Bi-Level		Tri-Level (Default)	
		Config Range	Default	Config Range	Default
Close	Open	10% - 70%	40%	10% - 70%	30%
Open	Close	10% - 70%	40%	10% - 70%	70%
Close	Close	100%	100%	100%	100%
Open	Open	0%	0%	0%	0%

WEIGHT

Item	lbs	kg
CUBE2-X	15.08	6.84
CUBE2-X-FT	17.63	8.00

CUBE2-X

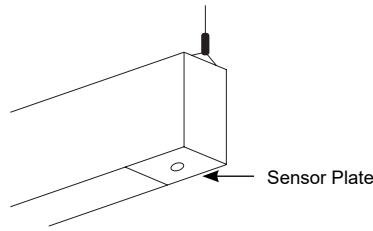

ORDERING INFORMATION

EXAMPLE: CUBE2-X-D27L-30K-UNV-X1-AC48

MODEL	LED Downlight (per/each section)		LED Uplight ¹ (per/each section)		Uplight DISTRIBUTION		COLOR TEMP.		SEPARATE COLOR TEMP. ¹	
CUBE2-X	D18L D27L D36L D54L	18W LED 27W LED 36W LED 54W LED	/U18L /U27L	18W LED 27W LED	(Blank) UN15 UN30 UM UASY UBAT UPC	No optic Uplight Narrow 15° Uplight Narrow 30° Uplight Medium 60° Uplight Asymmetric 20° ²⁰ Uplight Batwing 120° Non-optic clear cover	(Blank) -30K -35K -40K -50K	Leave blank if you wish to have different CCT for up and down, and fill out next section. 3000K 3500K 4000K 5000K	(Blank) DXXUYY	Leave blank if you wish to have different CCT for up and down, and fill out next section. Indicate 27,30,35,40 or 50 for XX and YY (D represents Downlight, U represents Uplight).
<small>* Maximum wattage per each section - pendant : 75W (up & down light) - recessed mount : 54W (down light) * Contact factory for custom wattage or lumen requirement.</small>										

CRI		MOUNTING		VOLTAGE		EM SECTION		FIXTURE FINISH ¹⁰	
(Blank) C9	80+ CRI 90+ CRI ⁹	(Blank) FT	Pendant Standard 1/2" Flange (drywall) ²	UNV 120 277 347	120-277V 120V 277V 347V ¹⁵	(Blank) 1SE	None EM 1 Section	(Blank) *BK *SV **CC *AMB	Matte White RAL #9003 (Std.) Black RAL #9011 Silver (RAL #9022) Custom Color ⁸ Anti-Microbial Coating (Matte Skye White) <small>* Non-standard finish with extra charge. ** Additional charge & set up fee.</small>

CORD FINISH (for pendant)		CANOPY FINISH (for pendant)		CEILING TYPE (for pendant)		SUSPENSION LENGTH (for pendant)	
(Blank) *BKC	White (Std.) Black	(Blank) *BC *SC **CSS	White (Std.) Black Canopy Silver Canopy Custom Canopy Color (White is Std.)	X1 X2 X3 X4	15/16" grid T-bar ceiling Hard ceiling Sloped Hard ceiling 9/16" T-bar ceiling	AC48 AC96 ST24 ST48	Adjustable Aircraft Cable Canopy 48"L Adjustable Aircraft Cable Canopy 96"L Stem Canopy 24"L Stem Canopy 48"L <small>* Contact factory for custom length.</small>
<small>* Non-standard finish with extra charge. ** Additional charge & set up fee.</small>							

CUBE2-X

LED DRIVER		OPTIONS	
(Blank)	0-10V dim to 1% (Std.) (dim both uplight and downlight simultaneously)	STB	Slip Through Bracket ³
UDSD	Separate Dimming Control of Uplight and Downlight (0-10V dim to 1%) ^{7, 14}	EM5MC	810 LUMEN Emergency Ballast (32°F (0°C) ~ 131°F (55°C))
SP	Separate Power Control for Uplight and Downlight	EM7MC	1134 LUMEN Emergency Ballast (32°F (0°C) ~ 122°F (50°C))
ES566	eldoLED SOLOdrive Natural Dimming to dark, 0-10V, 100% ~ 0.1% dim	EM10MC	1620 LUMEN Emergency Ballast (32°F (0°C) ~ 131°F (55°C))
SD40	40% / 100% Bi-Level Step dim	EMG25	4050 LUMEN EM Battery Backup (CEC Compliant EM) ^{18, 19}
SDXX	XX% / 100% Bi-Level Step dim (Specify XX : 10% ~ 70%)	EMC	CEC compliant EM ⁴
PHSR	Philips Xitanium Sensor-Ready, Dali 5%~100% dim.	GTD	Bodine Generator Transfer Device
PHDL	Philips Xitanium DALI driver, Dim to 5%	GTD10DIM	Bodine Generator Transfer Device (0-10VDC Dimmer Override)
ED560	eldoLED LightShape DALI dim to dark, 0.1% ~ 100%	GLR	Fast Blow Fuse ¹⁶
TDM	Triac Dim. (120V only)	GMF	Slow Blow Fuse ¹⁶
TD30/70	30% / 70% / 100% Tri-Level Step dim	ARRA	Assembled in USA for Buy American Act
TDXX/YY	XX% / YY% / 100% Tri-Level Step dim (Specify XX, YY : 10% ~ 70%)	BAA	BAA(Buy American Act) and BABA(Build America Buy America) compliant
LDE1	Hi-lume 1% EcoSystem LED driver with Soft-on, Fade-to-Black dimming technology, 100% ~ 1% dim	O7W	Optional 7 Years Limited Warranty ⁵
ELV	ELV compatible (reverse-phase or trailing-edge), (120V only)	O10W	Optional 10 Years Limited Warranty ⁵
TRIOT	Tridonic IoT ready, 1-100% dim via Smart Module Interface (SMI), automated dimming/lighting controls via Enlighted Sensor Interface	AMS	Bluetooth Mesh Wireless Sensor. Occupancy/Daylight/0-10V Dimming
DTO	0-10V DIM-TO-OFF	DPMS	Daylight Dimming Photo Sensor (0-10 VDC Control), (LSR-301-S required if FD-301 is installed) ¹⁷
DMX	DMX512 control system (Only available with RGB+W option)	SO	Dimming Wires connected to Sensor Only (available option on FS-205 non-Bluetooth AMS sensor only) ⁶
DLM	Wattstopper's DLM interface (Only available with RGB+W option)	LSR-301-S	Setup Remote Control for DPMS (Required for DPMS)
LTEA2W	Hi-lume 1% 2-wire LED driver (120V forward phase only)	LSR-301-P	Occupant Remote Control for DPMS
 BLT	Bluetooth Mesh System (contact factory for more information)	E1F	End feed on one end (Pre-drilled hole for 1/2" fitting)
		E2F	End feed on both ends (Pre-drilled holes for 1/2" fitting)

LIGHTING CONTROL SYSTEM	
LUTRON VIVE	<p><Lutron Vive System Enabled></p>  <p>Click Here!</p> <p><EasySense></p> <p>EasySense Fixture-mount occupancy sensing, daylight harvesting and task tuning in one device (Must be ordered with PHSR driver) ^{11, 12}</p> <p>SNS200</p> <p>RS-IR</p> <p>IR dongle v2.0 for EasySense control</p> <p><Enlighted></p> <p>SU-5E</p> <p>Enlighted IoT ready 0-10V Indoor Micro sensor with occupancy/vacancy detection, daylight harvesting, thermal sensing, task tuning, and room and zone control, Bluetooth enabled (Must be ordered with TRIOT) ¹³</p> <p>RS-WS</p> <p>Enlighted Room controller providing basic control functions of a standard wall switch with preset dimming capability</p> <p><Bluetooth></p> <p>IFS105SE</p> <p>Bluetooth Mesh Wireless Sensor. Occupancy/Daylight/0-10V Dimming</p> <p>PPA102S</p> <p>Bluetooth Powerpack (Consult factory for installation location)</p>

NOTES:

- Pendant only.
- Requires # STB as standard.
- Standard with "FT" mounting.
- Check with factory for more details.
- This limited warranty covers electrical parts only and does not apply to labor, equipment lease, or defect from improper installation or operation.
- Dimming wires provided and connected to sensor only, not for dimmer switch. (available with AMS and DPMS option)
- For separate dimming control, please be advised it may not be available when EM battery backup is added due to limited space. Please contact us for more information.
- Refer to color charts (RAL and/or Cardinal) in the separate attachment.
- Lumen per watt is around 15% less than standard CRI (80+).
- Cord is available in white or black. (Black is not available for the EM option)
- See NFC and IR manual in the separate attachment. If your phone is not compatible, please order "RS-IR" and follow the manual.
- Refer to Advanced Grouping Datasheet for its default setting and compatible wireless switches.
- "RS-WS" option can be added if wish to have a wall switch, please see Enlighted Room Controller in the separate attachment.
- Can have up to 2 power feeds depending on the configuration.
- 347V cannot work with Emergency Battery Backup.
- Must specify voltage, not available with 347V.
- Automatic on/off is not available. For automatic on/off, additional occupancy sensor is required or a manual on/off switch can be done.
- Contact factory for other emergency ballast options.
- For 3ft configuration, EM can only be remote mounted. Remote box is provided by others.
- Standard optic illuminates the wall. Optics can be field modified (reversed) to illuminate room.

CUBE2-X

- INACCESSIBLE CEILING MOUNTING

- SPECIALTY MOUNTS

Flange Detail

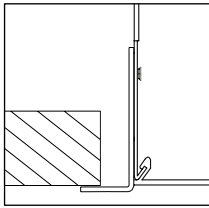

Exposed Flange Detail:
Specify FT in part #

Rotating Crossbar

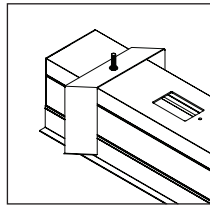

Unavailable Structure Support:
Specify STB in part #

Surface

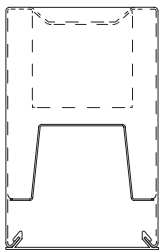

Drywall

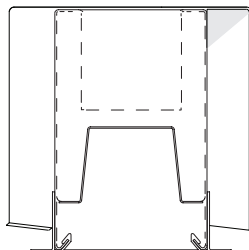

Cable

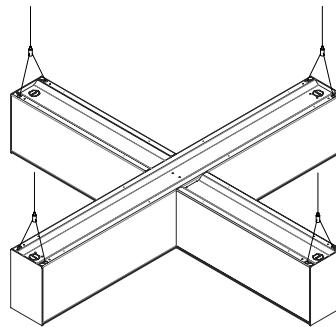

Stem

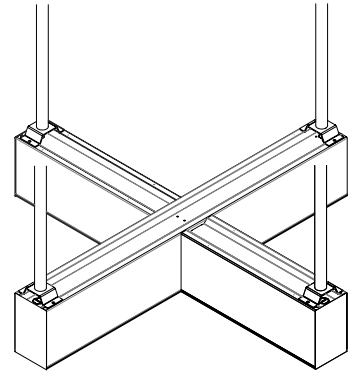

Pendant

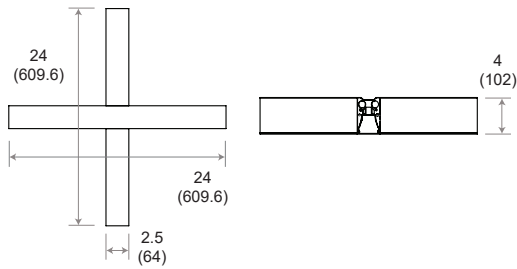

Drywall

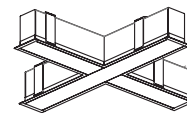
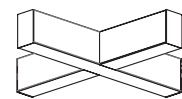
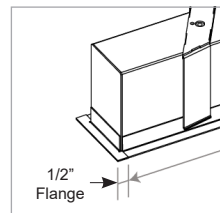
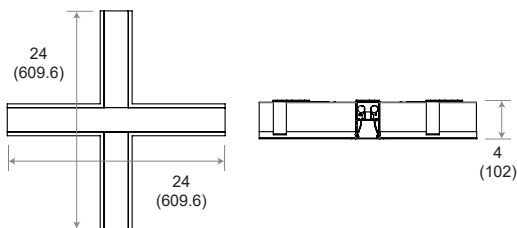

All dimensions are in inches (millimeters).

* Dimensions shown are without flange.

CUBE2-X

COMPATIBLE DIMMER SWITCH (TABLE 1)

Model #	Brand	Compatible Dimmer Switch	
(Blank)	-	<Leviton>	IP710-LFZ
		<Lutron>	Nova: NFTV-dimmer plus PP-DV relay pack(s) Nova T: NTSTV-DV-dimmer Diva: DVTV-dimmer, DVSCSTV-dimmer, plus PP-DV, relay pack(s), DVSTV-dimmer, DVSCSTV-dimmer GRAFIK Eye QS: QSGRJ-XP, plus GRX-TVI 0-10V interface GRAFIK Eye QS w/EcoSystem: QSGRJ-XE, QSGR-XE, plus GRX-TVI 0-10V interface PowPak: RMJ-5T
ES566	eldoLED SOLOdrive	<Busch-Jaeger>	2112U-101
		<Jung>	240-10
		<Leviton>	IlumaTech - IP710-DLX
		<Lightoller Controls>	ZP600FAM120
		<Merten>	5729
		<Pass & Seymour>	CD4FB-W
		<Wattstopper>	DCLV1
		<Sensor Switch>	nIO EZ
		<Synergy>	ISD BC
		<ABB>	SD/S 2.16.1
		<Lutron>	Nova T: NTFTV Diva - DVTV-xx, NFTV GRAFIK Eye: GRX-TVI w GRX3503 Energy Savr Node: QSN-4T16-S TVM2 Module
<Crestron>	GLX-DIMFLV8, GLXP-DIMFLV8, GLPAC-DIMFLV4-*, GLPAC-DIMFLV8-*, GLPP-DIMFLVEX-PM, GLPP-1DIMFLV2EX-PM, GLPP-1DIMFLV3EX-PM, DIN-A08, DIN-4DIMFLV4, CLS-EXP-DIMFLV, CLCI-1DIMFLV2EX		
ED560	eldoLED DUALdrive	<Lunatone>	SS-LUNAT PS2 30mA SS-LUNAT Touch or BT SS-LUNAT Comm
LDE1	Lutron 5-Series EcoSystem	<Lutron>	PowPak Dimming Modules: RMJ-ECO32-DV-B, FCJ/FCJS-ECO 1,2 Energi Savr Node (120V only): QSN-1ECO-S, QSN-2ECO-S GRAFIK Eye QS/Homeworks QS control unit (120V only): QSGRJ-_E(wireless) QSGR-_E Quantum Hub (120V only): QP2-_2C/4C/6C/8C Homeworks QS/myRoom Plus power module (120V only): LQSE-2ECO-D
PHSR 3	Philips Xitanium Sensor-Ready	<Ilumra>	<u>Single Rocker Self-Powered Light Switch (on/off, dim-up/down)</u> Ilumra# ZBT-S1AWH Digi-Key# 1082-1033-ND <u>Dual Rocker Self-Powered Light Switch (on/off, dim-up/down, scene1,2)</u> Ilumra# ZBT-S2AWH Digi-Key# 1082-1034-ND
TDM	KEYSTONE	<Lutron>	Diva DV-600P, SkyLark S-600P, Ariadni AY-600P, Ariadni TG-603P, Maestro MA-600 (Digital), Diva CFL/LED DVCL-153P, Satin Colors DVSC-600P-SW
		<Leviton>	6641, IlumaTech IPI06-1LX, ToggleTouch TGI06-1LW (Digital)
ELV	KEYSTONE	<Lutron>	MAELV-600BL (Digital), DVELV-300P, SkyLark SELV-300P
DTO	Philips Xitanium Gen.2 Philips Xitanium Sensor-Ready	<Lutron>	Nova T: #NTSTV-DV http://www.lutron.com/TechnicalDocumentLibrary/NovaTB.pdf See page13.
LTEA2W	Lutron Hi-lume 2-wire (120V forward voltage only)	<Lutron>	Visit http://www.lutron.com/TechnicalDocumentLibrary/369543_ENG.pdf for a list of compatible dimmer switches.

NOTES:

1. All devices connected to one FCJ/FCJS-ECO will be controlled together. Devices will dim to the same level as the result of a control command.
For more detail on adjusting low-end light level refer to Application Note#556 at www.lutron.com.
2. For the Line/Hot (L/H) terminal on the driver, it is preferred not to use the switched hot (red) wire from the control but rather the hot wire directly from the power source.
3. Recommended for EasySense System.

CUBE2-X

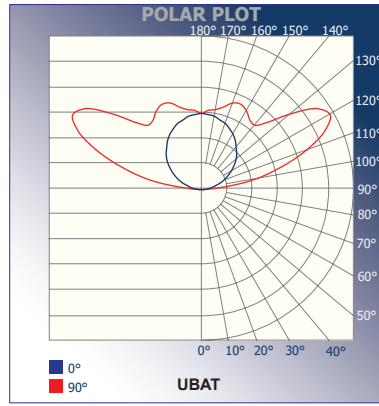
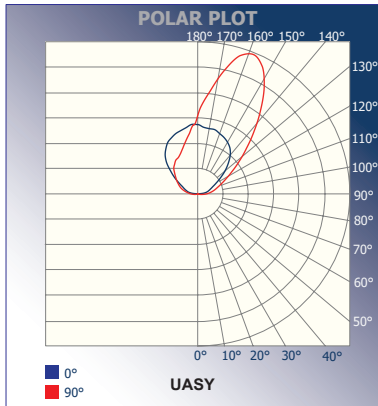
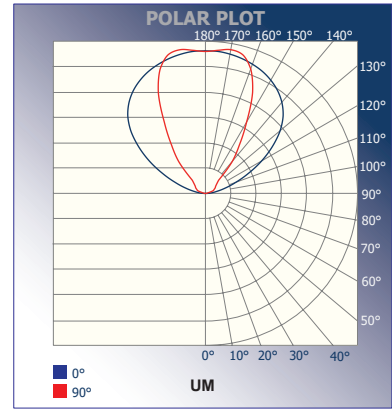
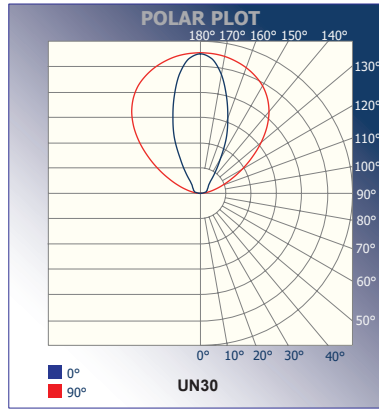
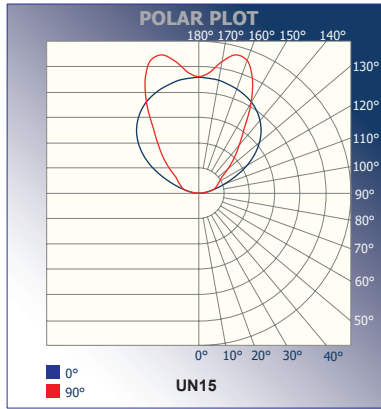

SIDE VIEW

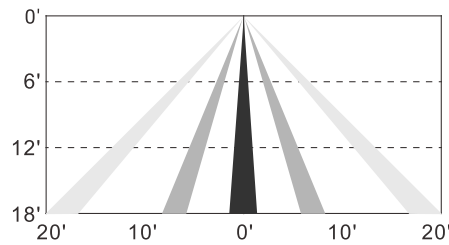

TOP VIEW

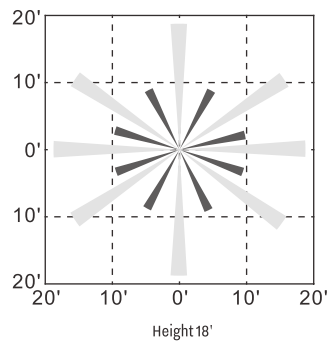

AMS, IFS105SE coverage pattern