

CUBE4-HC90

Project Name:	
Type:	

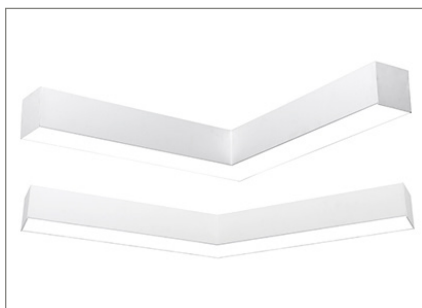

APPLICATION

The CUBE4-HC90 creates a design statement for contemporary and traditional architectural interiors. The angular luminaires are decorative and suitable for a multiple of applications like offices, retails, museums and galleries as well as high ceiling application such as lobbies.

FEATURE:

- Housing is formed by cold-rolled steel with a highly reflective die-formed white painted steel reflector.
- The snap-in acrylic lens has a matte finish and a diffuser (.125" thick) which is removable for lamp replacement.
- 90 degree and 135 degree luminaires are available.

MOUNTING:

- Pendant, surface, wall mount, recessed (drywall and T-bar) mount available.
- Mounting restrictions apply on some of the recessed housings, please refer to the ordering chart or dimension page to find availability.

LED:

- High quality array LEDs.
- LM80
- Color Temperature: 3000/3500/4000/5000 (K)
- Color Rendering Index: > 80 (optional>90).
- Nominal Lamp Life: 100,000 hours.
- Reported L70 hours: +60,000 (55°C).

ELECTRICAL:

- High power factor electronic driver, operate from a 120 ~ 277 Vac input range, 50 / 60 Hz.
- Features included over voltage protection, surge, short circuit protection and over load protection.
- Power Factor: typical > 0.95, THD <20, meets Class1 or Class 2 circuit.
- 0-10V dimmable driver as standard.
- 0-10VDC dimming 1%~100%.
- Operating temperature: -4°F (-20°C) ~ 122°F (50°C).

<ELCU-200>

- Guarantees emergency lighting remains ON or is turned on when power to the control device is lost.
- Interfaces with fire alarm panel or security system.
- "Watchdog" feature allows emergency loads to be controlled in tandem with normal power loads.
- UL listed for use in emergency circuits.

FINISH:

- Standard powder-coat textured white painted finish on exposed trim, consult factory for custom colors.
- Comes with snap-in acrylic lens as standard.

LISTING:

- UL / CUL listed.
- Listed to UL 1598 and UL 8750.
- UL listed for dry & damp location.
- Assembled in USA (optional).
- BAA compliant (optional).
- 5 years limited warranty.
- 7 or 10 years limited warranty. (optional) ⁵
- Bluetooth Mesh System available, please contact factory for more information.

ORDERING INFORMATION

EXAMPLE: CUBE4-HC90-12-D27L-30K-UNV-X1-AC48

MODEL	Shape		Size		LED Downlight (per/each section)		LED Uplight ¹ (per/each section)		Uplight DISTRIBUTION		COLOR TEMP.			
					D18L	D27L	D36L	D54L	/U18L	/U27L	(Blank)	UN15	UN30	UM
CUBE4	HC90	90 Degree	11	1' x 1'										
			12	1' x 2'										
			21	2' x 1'										
			22	2' x 2'										
	HC135	135 Degree	22	2' x 2'										

* Maximum wattage per each section
 - pendant : 75W(up & down light)
 - recessed mount : 54W(down light)
¹ Contact factory for custom wattage or lumen requirement.

SEPARATE COLOR TEMP. ¹		CRI		MOUNTING		VOLTAGE	
(Blank)	Leave blank if you wish to have different CCT for up and down, and fill out next section.	(Blank)	80+ CRI	(Blank)	Pendant	UNV	120-277V
DXXUY	Indicate 27,30,35,40 or 50 for XX and YY (D represents Downlight, U represents Uplight).	C9	90+ CRI ⁹	FT	Standard 1/2" Flange (drywall) ²	120	120V
				G1	9/16", 15/16", 1" T-bar Ceiling Grid ^{15,20}	277	277V
				SF	Spackle Flange (Trimless) ^{16,17,20}	347	347V ¹⁸
				S	Ceiling Surface		
				W	Wall		

¹ Limited mounting option(s) depending on the shape & size. Please see dimensions page to find availability.

EM SECTION		FIXTURE FINISH ¹⁰		CORD FINISH (for pendant)		CANOPY FINISH (for pendant)		CEILING TYPE (for pendant)	
(Blank) 1SE	None EM 1 Section	(Blank) *BK *SV **CC *AMB	Matte White RAL #9003 (Std.) Black RAL #9011 Silver (RAL #9022) Custom Color ⁸ Anti-Microbial Coating (Matte Skye White)	(Blank) *BKC	White (Std.) Black	(Blank) *BC *SC **CSS	White (Std.) Black Canopy Silver Canopy Custom Canopy Color (White is Std.)	X1 X2 X3 X4	15/16" grid T-bar ceiling Hard ceiling Sloped Hard ceiling 9/16" T-bar ceiling
* Non-standard finish with extra charge. ** Additional charge & set up fee.									

SUSPENSION LENGTH (for pendant)		LED DRIVER									
AC48 AC96 ST24 ST48	Adjustable Aircraft Cable Canopy 48"L Adjustable Aircraft Cable Canopy 96"L Stem Canopy 24"L Stem Canopy 48"L * Contact factory for custom length.	(Blank) UDSD SP ES566 SD40 SDXX PHSR PHDL ED560 TDM TD30/70 TDXX/YY LDE1 ELV TRIOT DTO DMX DLM LTEA2W	0-10V dim to 1% (Std.) (dim both uplight and downlight simultaneously) Separate Dimming Control of Uplight and Downlight (0-10V dim to 1%) ^{7, 14} Separate Power Control for Uplight and Downlight eldoLED SOLOdrive Natural Dimming to dark, 0-10V, 100% ~ 0.1% dim 40% / 100% Bi-Level Step dim XX% / 100% Bi-Level Step dim (Specify XX : 10% ~ 70%) Philips Xitanium Sensor-Ready, Dali 5%~100% dim. Philips Xitanium DALI driver, Dim to 5% eldoLED LightShape DALI dim to dark, 0.1% ~ 100% Triac Dim. (120V only) 30% / 70% / 100% Tri-Level Step dim XX% / YY% / 100% Tri-Level Step dim (Specify XX, YY : 10% ~ 70%) Hi-lume 1% EcoSystem LED driver with Soft-on, Fade-to-Black dimming technology, 100% ~ 1% dim ELV compatible (reverse-phase or trailing-edge), (120V only) Tridonic IoT ready, 1-100% dim via Smart Module Interface (SMI), automated dimming/lighting controls via Enlighted Sensor Interface 0-10V DIM-TO-OFF DMX512 control system (Only available with RGB+W option) Wattstopper's DLM interface (Only available with RGB+W option) Hi-lume 1% 2-wire LED driver (120V forward phase only)								
			BLT	Bluetooth Mesh System (contact factory for more information)							

OPTIONS		LIGHTING CONTROL SYSTEM		
STB EMG8 EMG15 EMG20 EMG25 EMC GTD GTD10DIM GLR GMF ARRA BAA O7W O10W AMS DPMS SO LSR-301-S LSR-301-P E1F E2F	Slip Through Bracket ³ 1296 LUMEN EM Battery Backup (CEC Compliant EM) ²¹ 2430 LUMEN EM Battery Backup (CEC Compliant EM) ²¹ 3240 LUMEN EM Battery Backup (CEC Compliant EM) ²¹ 4050 LUMEN EM Battery Backup (CEC Compliant EM) ²¹ CEC compliant EM ⁴ Bodine Generator Transfer Device Bodine Generator Transfer Device (0-10VDC Dimmer Override) Fast Blow Fuse ¹⁹ Slow Blow Fuse ¹⁹ Assembled in USA for Buy American Act BAA(Buy American Act) and BABA(Build America Buy America) compliant Optional 7 Years Limited Warranty ⁵ Optional 10 Years Limited Warranty ⁵ Bluetooth Mesh Wireless Sensor. Occupancy/Daylight/0-10V Dimming Daylight Dimming Photo Sensor (0-10 VDC Control), (LSR-301-S required if FD-301 is installed) ²² Dimming Wires connected to Sensor Only (available option on FS-205 non-Bluetooth AMS sensor only) ⁶ Setup Remote Control for DPMS (Required for DPMS) Occupant Remote Control for DPMS End feed on one end (Pre-drilled hole for 1/2" fitting) End feed on both ends (Pre-drilled holes for 1/2" fitting)	LUTRON VIVE SNS200 RS-IR SU-5E RS-WS IFS105SE PPA102S	<p><Lutron Vive System Enabled></p>  Click Here!	<p><EasySense></p> <p>EasySense Fixture-mount occupancy sensing, daylight harvesting and task tuning in one device (Must be ordered with PHSR driver) ^{11, 12}</p> <p>IR dongle v2.0 for EasySense control</p> <p><Enlighted></p> <p>Enlighted IoT ready 0-10V Indoor Micro sensor with occupancy/vacancy detection, daylight harvesting, thermal sensing, task tuning, and room and zone control, Bluetooth enabled (Must be ordered with TRIOT) ¹³</p> <p>Enlighted Room controller providing basic control functions of a standard wall switch with preset dimming capability</p> <p><Bluetooth></p> <p>Bluetooth Mesh Wireless Sensor. Occupancy/Daylight/0-10V Dimming</p> <p>Bluetooth Powerpack (Consult factory for installation location)</p>

NOTES:

- Pendant only.
- Requires # STB as standard.
- Standard with "FT" mounting.
- Check with factory for more details.
- This limited warranty covers electrical parts only and does not apply to labor, equipment lease, or defect from improper installation or operation.
- Dimming wires provided and connected to sensor only, not for dimmer switch. (available with AMS and DPMS option)
- For separate dimming control, please be advised it may not be available when EM battery backup is added due to limited space. Please contact us for more information.
- Refer to color charts (RAL and/or Cardinal) in the separate attachment.
- Lumen per watt is around 15% less than standard CRI (80+).
- Cord is available in white or black. (Black is not available for the EM option)

- See NFC and IR manual in the separate attachment. If your phone is not compatible, please order "RS-IR" and follow the manual.
- Refer to Advanced Grouping Datasheet for its default setting and compatible wireless switches.
- "RS-WS" option can be added if wish to have a wall switch, please see Enlighted Room Controller in the separate attachment.
- Can have up to 2 power feeds depending on the configuration.
- Compatible with X1 ceiling type.
- Requires # STB as standard.
- Compatible with X2 ceiling type.
- 347V cannot work with Emergency Battery Backup.
- Must specify voltage, not available with 347V.
- Only available with HC90-22.
- Contact factory for other emergency ballast options.
- Automatic on/off is not available. For automatic on/off, additional occupancy sensor is required or a manual on/off switch can be done.
- Standard optic illuminates the wall. Optics can be field modified (reversed) to illuminate room.

CUBE4-HC90

OUTPUT CURRENT

		Bi-Level		Tri-Level (Default)	
SW1	SW2	Config Range	Default	Config Range	Default
Close	Open	10% - 70%	40%	10% - 70%	30%
Open	Close	10% - 70%	40%	10% - 70%	70%
Close	Close	100%	100%	100%	100%
Open	Open	0%	0%	0%	0%

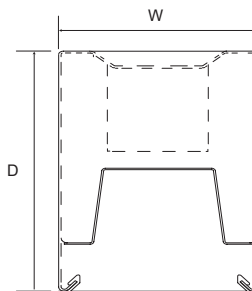

Width: 4 (101)
Depth: 4 (101)

All dimensions are in inches (millimeters).

WEIGHT

Item	lbs	kg
CUBE4-HC90	17.84	8.09
CUBE4-HC90-FT	19.49	8.84

CONFIGURATIONS

Series	Model #	AC Input	Fixture Lumen Output		Lumen Efficiency
CUBE4-HC90-11	18L	9.9W	1209.58 lm (100% Down)		1209.6 lm 122.18 lm/W
	27L	14.85W	1868.7 lm (100% Down)		1868.7 lm 125.84 lm/W
	36L	19.8W	2482.1 lm (100% Down)		2482.1 lm 125.36 lm/W
	48L	26.4W	3073.65 lm (100% Down)		3073.65 lm 116.4 lm/W
	54L	29.7W	3507.57 lm (100% Down)		3507.57 lm 118.10 lm/W
	18L/18L	19.8W	1187.4 lm (49.5% Down) / 1211.55 lm(50.5% Up)		2398.95 lm 121.15 lm/W
	27L/18L	24.75W	1870.87 lm (60.6% Down) / 1216.38 lm (39.4% Up)		3087.25 lm 124.73 lm/W
	27L/27L	29.7W	1863.6 lm (51.1% Down) / 1783.35 lm (48.9% Up)		3646.95 lm 122.79 lm/W
	36L/18L	29.7W	2312.1 lm (66.1% Down) / 1185.9 lm (33.9% Up)		3498 lm 117.77 lm/W
	36L/27L	34.65W	2492.9 lm (57.7% Down) / 1827.7 lm (42.3% Up)		4320.6 lm 124.69 lm/W
	48L/18L	36.3W	2850.1 lm (70.5% Down) / 1192.7 lm (29.5% Up)		4042.8 lm 111.37 lm/W
	48L/27L	41.25W	3029.2 lm (62.9% Down) / 1786.7 lm (37.1% Up)		4815.9 lm 121.15 lm/W
	54L/18L	39.6W	3316.68 lm (73.5% Down) / 1195.82 lm (26.5% Up)		4512.5 lm 113.9 lm/W
	54L/27L	44.55W	3468 lm (66.1% Down) / 1778.65 lm (33.9% Up)		5246.65 lm 117.77 lm/W
CUBE4-HC90-12 CUBE4-HC90-21	18L	14.85W	1814.3 lm (100% Down)		1814.3 lm 122.18 lm/W
	27L	22.27W	2802.45 lm (100% Down)		2802.45 lm 125.84 lm/W
	36L	29.7W	3723.19 lm (100% Down)		3723.19 lm 125.36 lm/W
	48L	39.6W	4610.48 lm (100% Down)		4610.48 lm 116.4 lm/W
	54L	44.55W	5261.3 lm (100% Down)		5261.3 lm 118.10 lm/W
	18L/18L	29.7W	1781.2 lm (49.5% Down) / 1817.2 lm(50.5% Up)		3598.4 lm 121.15 lm/W
	27L/18L	37.12W	2806.3 lm (60.6% Down) / 1824.57 lm (39.4% Up)		4630.87 lm 124.73 lm/W
	27L/27L	44.55W	2795.3 lm (51.1% Down) / 2675.1 lm (48.9% Up)		5470.4 lm 122.79 lm/W
	36L/18L	44.55W	3468.2 lm (66.1% Down) / 1778.8 lm (33.9% Up)		5247 lm 117.77 lm/W
	36L/27L	51.97W	3739.4 lm (57.7% Down) / 2741.5 lm (42.3% Up)		6480.9 lm 124.69 lm/W
	48L/18L	54.45W	4275.3 lm (70.5% Down) / 1788.95 lm (29.5% Up)		6064.25 lm 111.37 lm/W
	48L/27L	61.8W	4543.8 lm (62.9% Down) / 2680.05 lm (37.1% Up)		7223.85 lm 121.15 lm/W
	54L/18L	59.4W	4975 lm (73.5% Down) / 1793.75 lm (26.5% Up)		6768.75 lm 113.9 lm/W
	54L/27L	66.82W	5201.66 lm (66.1% Down) / 2667.73 lm (33.9% Up)		7869.39 lm 117.77 lm/W
CUBE4-HC90-22 CUBE4-HC135-22	18L	19.8W	2419.2 lm (100% Down)		2419.2 lm 122.18 lm/W
	27L	29.7W	3737.5 lm (100% Down)		3737.5 lm 125.84 lm/W
	36L	39.6W	4964.4 lm (100% Down)		4964.4 lm 125.36 lm/W
	48L	52.8W	6147.4 lm (100% Down)		6147.4 lm 116.4 lm/W
	54L	59.4W	7015.7 lm (100% Down)		7015.7 lm 118.10 lm/W
	18L/18L	39.6W	2374.96 lm (49.5% Down) / 2422.94 lm(50.5% Up)		4797.9 lm 121.15 lm/W
	27L/18L	49.5W	3741.7 lm (60.6% Down) / 2432.8 lm (39.4% Up)		6174.5 lm 124.73 lm/W
	27L/27L	59.4W	3727.18 lm (51.1% Down) / 3566.72 lm (48.9% Up)		7293.9 lm 122.79 lm/W
	36L/18L	59.4W	4624.4 lm (66.1% Down) / 2371.7 lm (33.9% Up)		6996.1 lm 117.77 lm/W
	36L/27L	69.3W	4985.9 lm (57.7% Down) / 3655.3 lm (42.3% Up)		8641.2 lm 124.69 lm/W
	48L/18L	72.6W	5700.4 lm (70.5% Down) / 2385.27 lm (29.5% Up)		8085.67 lm 111.37 lm/W
	48L/27L	82.5W	6058.4 lm (62.9% Down) / 3573.4lm (37.1% Up)		9631.8 lm 121.15 lm/W
	54L/18L	79.2W	6633.3 lm (73.5% Down) / 2391.7 lm (26.5% Up)		9025 lm 113.9 lm/W
	54L/27L	89.1W	6936 lm (66.1% Down) / 3557.3 lm (33.9% Up)		10493.30 lm 117.77 lm/W

CUBE4-HC90

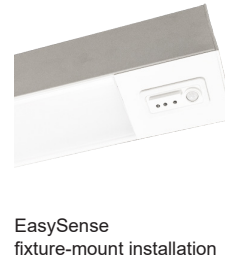
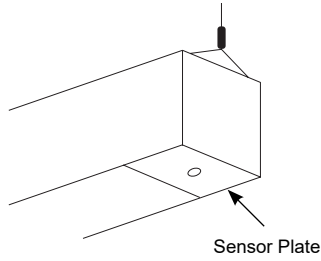

Surface

Drywall

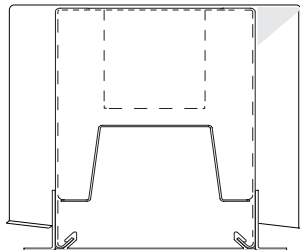
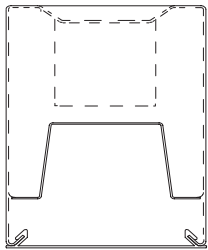

Cable

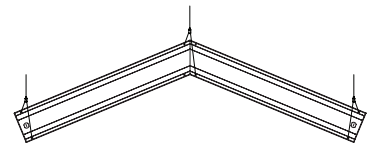
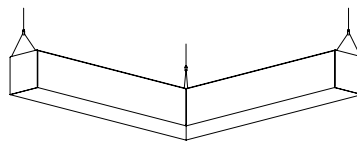

- INACCESSIBLE
CEILING MOUNTING

- SPECIALTY MOUNTS

Stem

Flange Detail

Rotating Crossbar

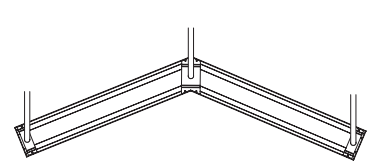
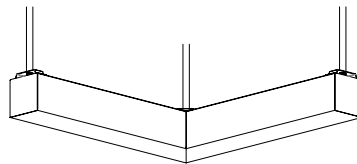
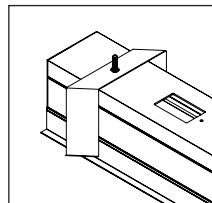
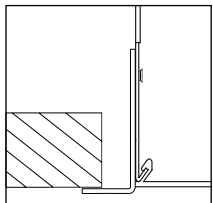

Exposed Flange Detail:
Specify FT in part #

Unavailable Structure Support:
Specify STB in part #

CUBE4-HC90

Pendant & Surface & Wall

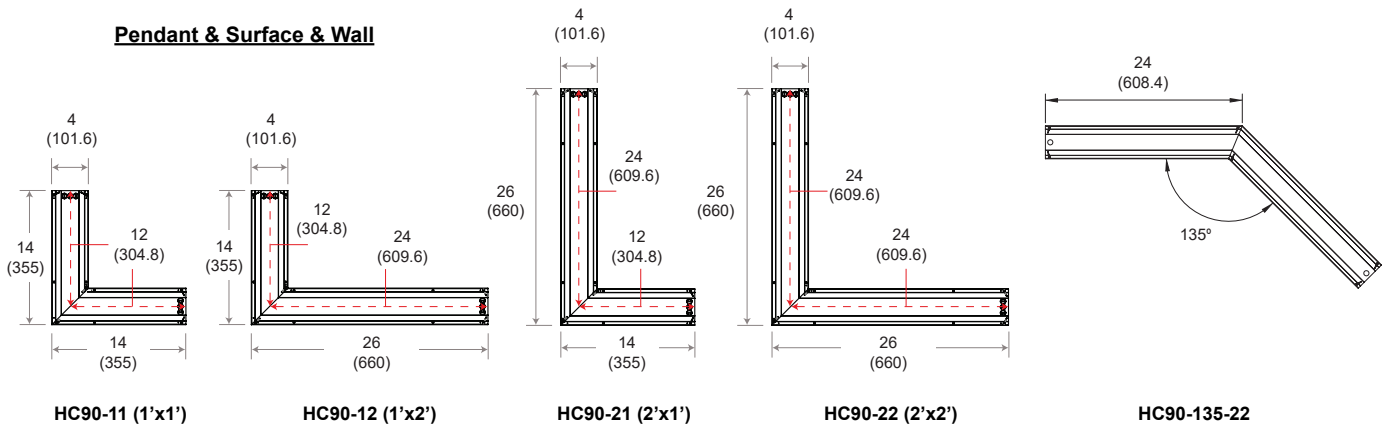

Recessed

* Measurements shown below are without flange.

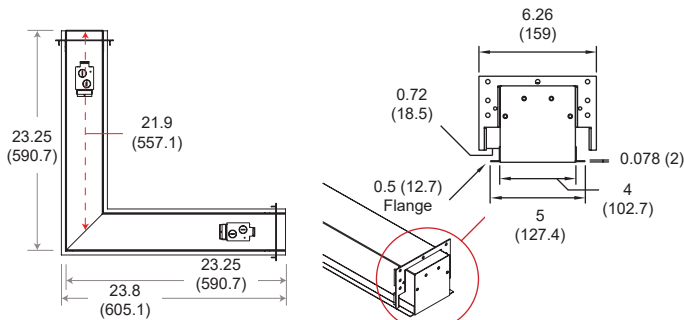
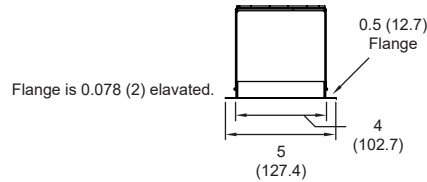
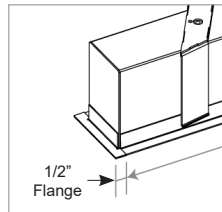
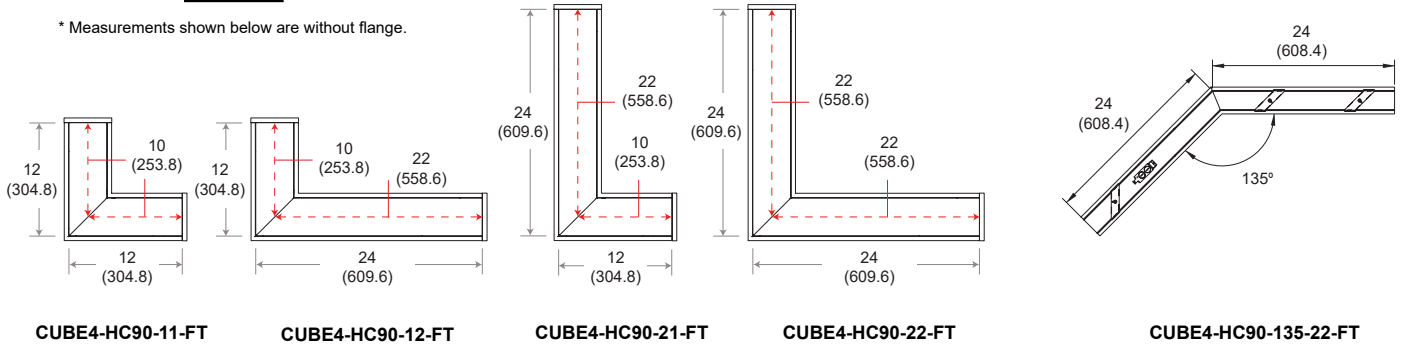

CUBE4-HC90-22-G1

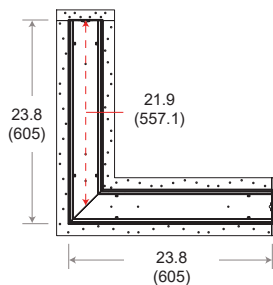

CUBE4-HC90-22-SF

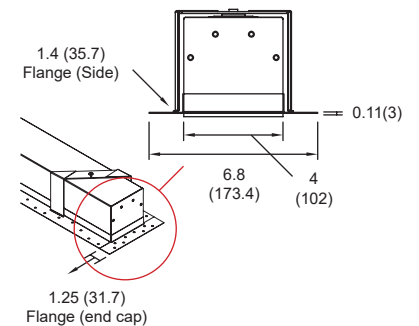

CUBE4-HC90

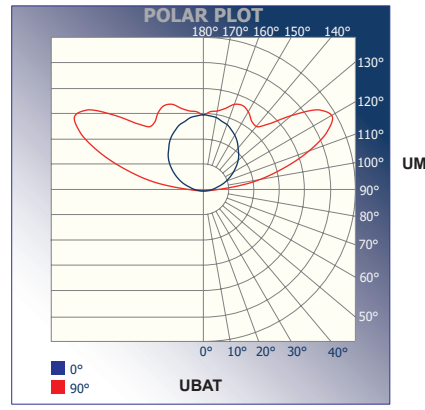
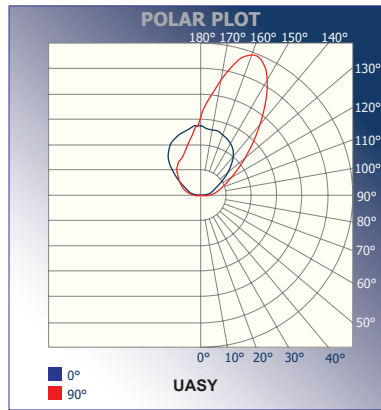
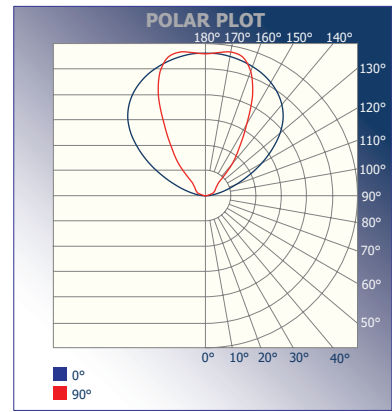
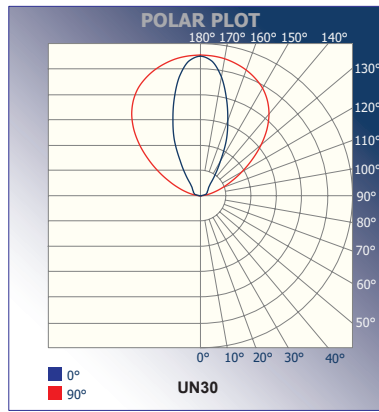
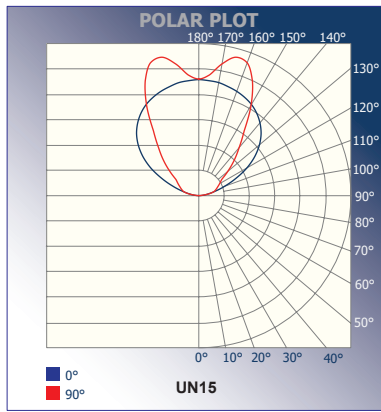

SIDE VIEW

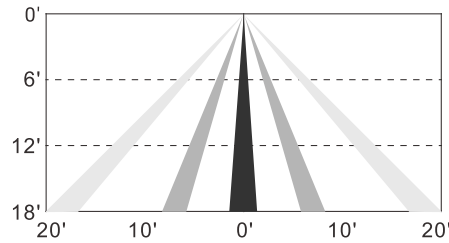

TOP VIEW

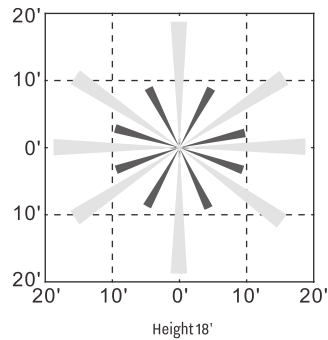

AMS, IFS105SE coverage pattern

CUBE4-HC90

COMPATIBLE DIMMER SWITCH (TABLE 1)

Model #	Brand	Compatible Dimmer Switch	
(Blank)	-	<Leviton>	IP710-LFZ
		<Lutron>	Nova: NFTV-dimmer plus PP-DV relay pack(s) Nova T: NTSTV-DV-dimmer Diva: DVTV-dimmer, DVSCTV-dimmer, plus PP-DV, relay pack(s), DVSTV-dimmer, DVSCSTV-dimmer GRAFIK Eye QS: QSGRJ-XP, plus GRX-TVI 0-10V interface GRAFIK Eye QS w/EcoSystem: QSGRJ-XE, QSGR-XE, plus GRX-TVI 0-10V interface PowPak: RMJ-5T
ES566	eldoLED SOLOdrive	<Busch-Jaeger>	2112U-101
		<Jung>	240-10
		<Leviton>	IllumaTech - IP710-DLX
		<Lightoller Controls>	ZP600FAM120
		<Merten>	5729
		<Pass & Seymour>	CD4FB-W
		<Wattstopper>	DCLV1
		<Sensor Switch>	nIO EZ
		<Synergy>	ISD BC
		<ABB>	SD/S 2.16.1
		<Lutron>	Nova T: NTFTV Diva - DVTV-xx, NFTV GRAFIK Eye: GRX-TVI w GRX3503 Energy Savr Node: QSN-4T16-S TVM2 Module
<Crestron>	GLX-DIMFLV8, GLXP-DIMFLV8, GLPAC-DIMFLV4*, GLPAC-DIMFLV8*, GLPP-DIMFLVEX-PM, GLPP-1DIMFLV2EX-PM, GLPP-1DIMFLV3EX-PM, DIN-AO8, DIN-4DIMFLV4, CLS-EXP-DIMFLV, CLC1-1DIMFLV2EX		
ED560	eldoLED DUALdrive	<Lunatone>	SS-LUNAT PS2 30mA SS-LUNAT Touch or BT SS-LUNAT Comm
LDE1	Lutron 5-Series EcoSystem	<Lutron>	PowPak Dimming Modules: RMJ-ECO32-DV-B, FCJ/FCJS-ECO ^{1,2} Energi Savr Node (120V only): QSN-1ECO-S, QSN-2ECO-S GRAFIK Eye QS/Homeworks QS control unit (120V only): QSGRJ-_E(wireless) QSGR-_E Quantum Hub (120V only): QP2-_2C/4C/6C/8C Homeworks QS/myRoom Plus power module (120V only): LQSE-2ECO-D
PHSR ³	Philips Xitanium Sensor-Ready	<Illumra>	<u>Single Rocker Self-Powered Light Switch (on/off, dim-up/down)</u> Illumra# ZBT-S1AWH Digi-Key# 1082-1033-ND <u>Dual Rocker Self-Powered Light Switch (on/off, dim-up/down, scene1,2)</u> Illumra# ZBT-S2AWH Digi-Key# 1082-1034-ND
TDM	KEYSTONE	<Lutron>	Diva DV-600P, SkyLark S-600P, Ariadni AY-600P, Ariadni TG-603P, Maestro MA-600 (Digital), Diva CFL/LED DVCL-153P, Satin Colors DVSC-600P-SW
		<Leviton>	6641, IllumaTech IPI06-1LX, ToggleTouch TGI06-1LW (Digital)
ELV	KEYSTONE	<Lutron>	MAELV-600BL (Digital), DVELV-300P, SkyLark SELV-300P
DTO	Philips Xitanium Gen.2 Philips Xitanium Sensor-Ready	<Lutron>	Nova T: #NTSTV-DV http://www.lutron.com/TechnicalDocumentLibrary/NovaTB.pdf See page13.
LTEA2W	Lutron Hi-lume 2-wire (120V forward voltage only)	<Lutron>	Visit http://www.lutron.com/TechnicalDocumentLibrary/369543_ENG.pdf for a list of compatible dimmer switches.

NOTES:

1. All devices connected to one FCJ/FCJS-ECO will be controlled together. Devices will dim to the same level as the result of a control command. For more detail on adjusting low-end light level refer to Application Note#556 at www.lutron.com.
2. For the Line/Hot (L/H) terminal on the driver, it is preferred not to use the switched hot (red) wire from the control but rather the hot wire directly from the power source.
3. Recommended for EasySense System.